

181115/181190XH GAMET

Tapered roller bearings

TYPE: Roller bearings, Tapered, Precision, GAMET type H, double-row, flanged cup

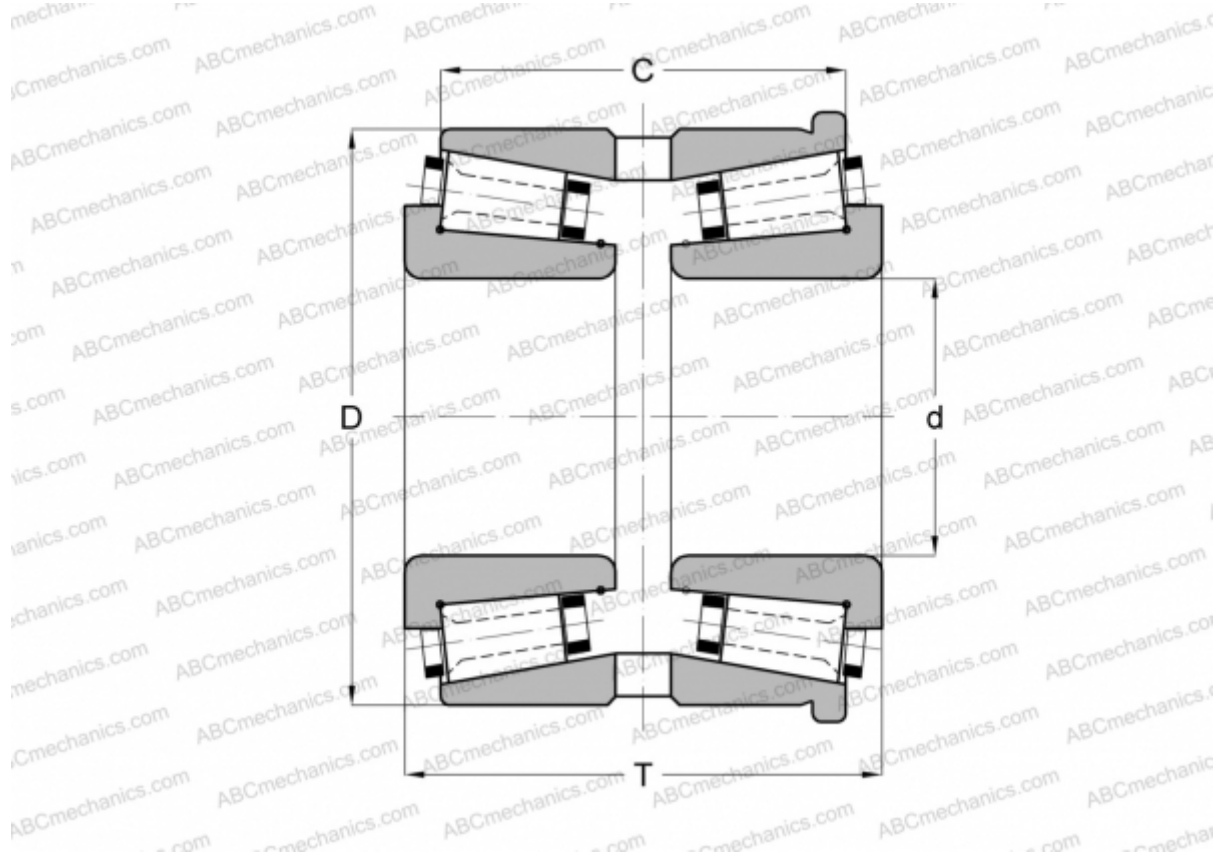

Technical specification

DIMENSIONS, MM

d	115,000
D	190,500
T	108,000
C	82,600

WEIGHT, KG 9,900

MANUFACTURER [GAMET](#)