

## 232431X/232533XH GAMET

Tapered roller bearings

TYPE: Roller bearings, Tapered, Precision, GAMET type H, double-row, flanged cup

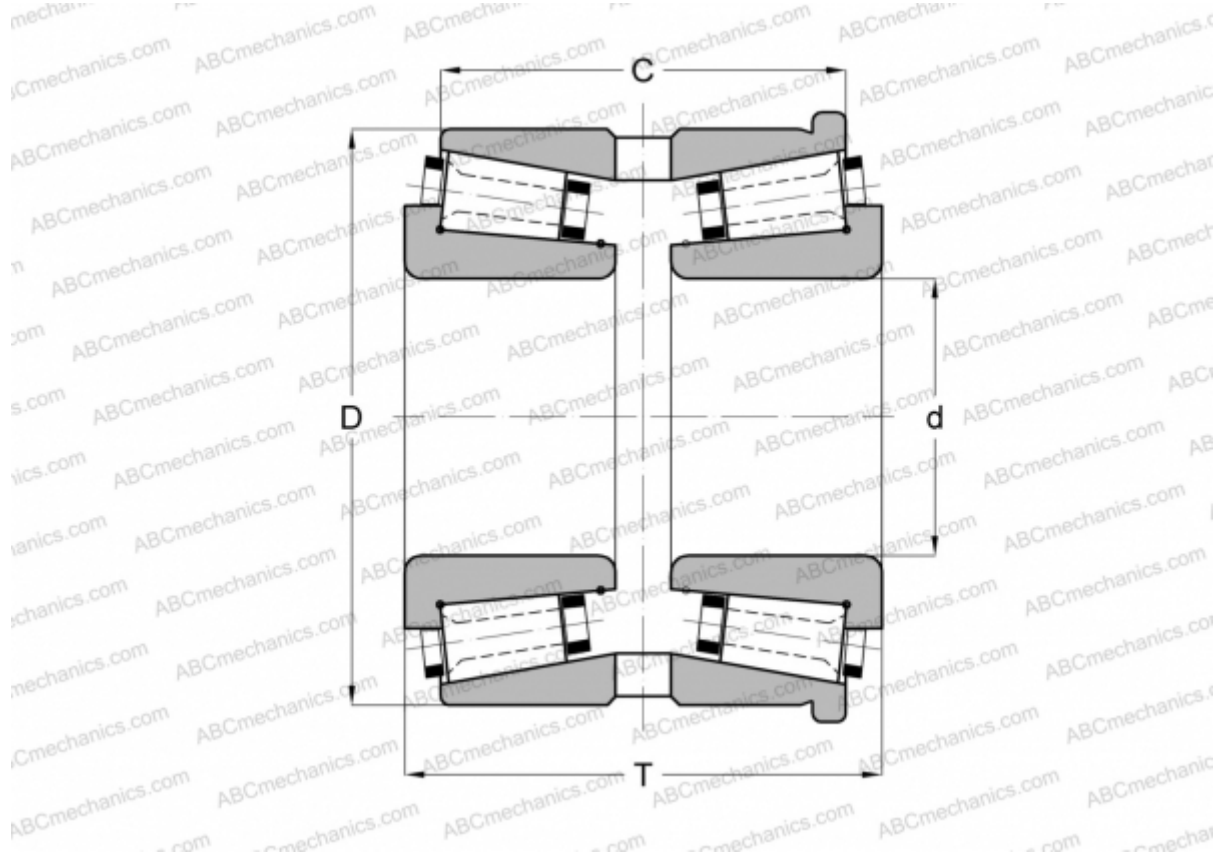

### Technical specification

#### DIMENSIONS, MM

d	431,800
D	533,400
T	123,000
C	100,780

**WEIGHT, KG** 45,000

**MANUFACTURER** [GAMET](#)