

## 802159 FAG

Tapered roller bearings

TYPE: Roller bearings, Tapered, Four row, Inch size, design 1 (FAG)

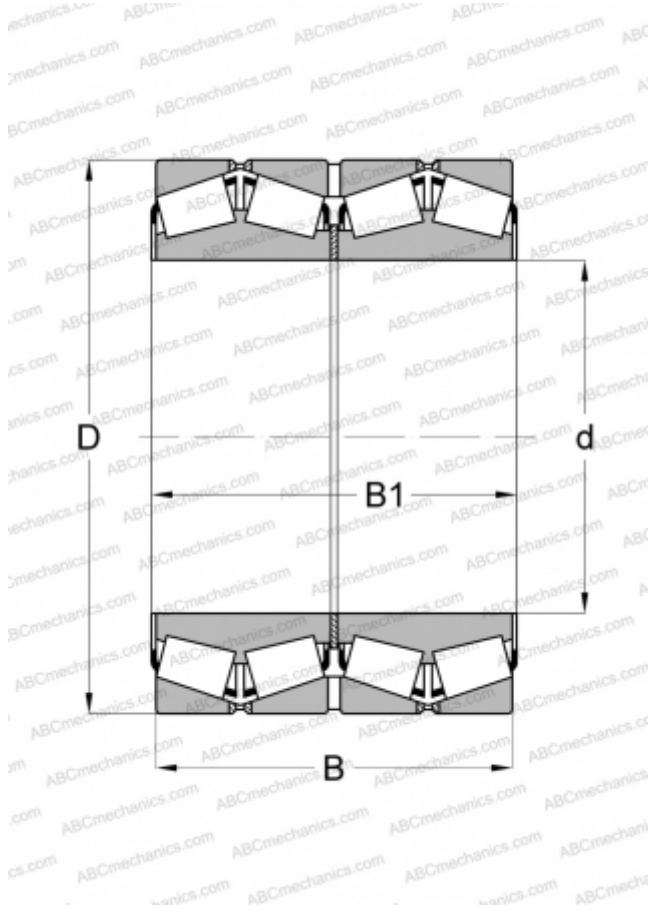

### Technical specification

#### DIMENSIONS, MM

d	165,100
D	225,425
B	168,275
B1	165,100

#### WEIGHT, KG

19,800

#### MANUFACTURER

[FAG](#)

#### INTERCHANGE

TIMKEN	<a href="#">46791DW.720.721D</a>
--------	----------------------------------