

508776A FAG

Tapered roller bearings

TYPE: Roller bearings, Tapered, Four row, Inch size, design 1 (FAG)

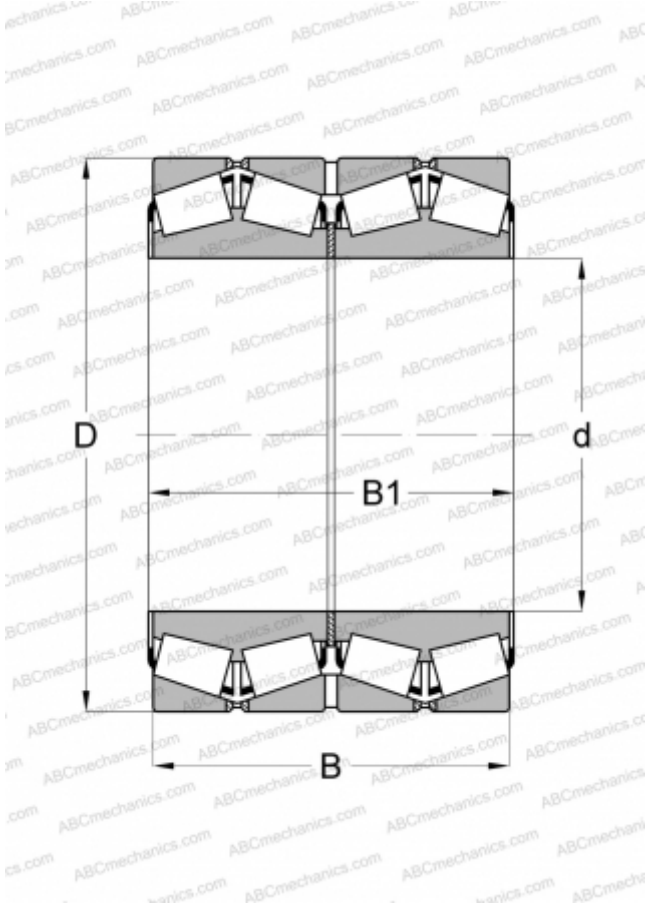

Technical specification

DIMENSIONS, MM

d	187,325
D	269,875
B	211,138
B1	211,138

WEIGHT, KG

40,000

MANUFACTURER

[FAG](#)

INTERCHANGE

TIMKEN

[M238849DW.810.810D](#)