

## 574331 FAG

Tapered roller bearings

TYPE: Roller bearings, Tapered, Four row, Inch size, design 1 (FAG)

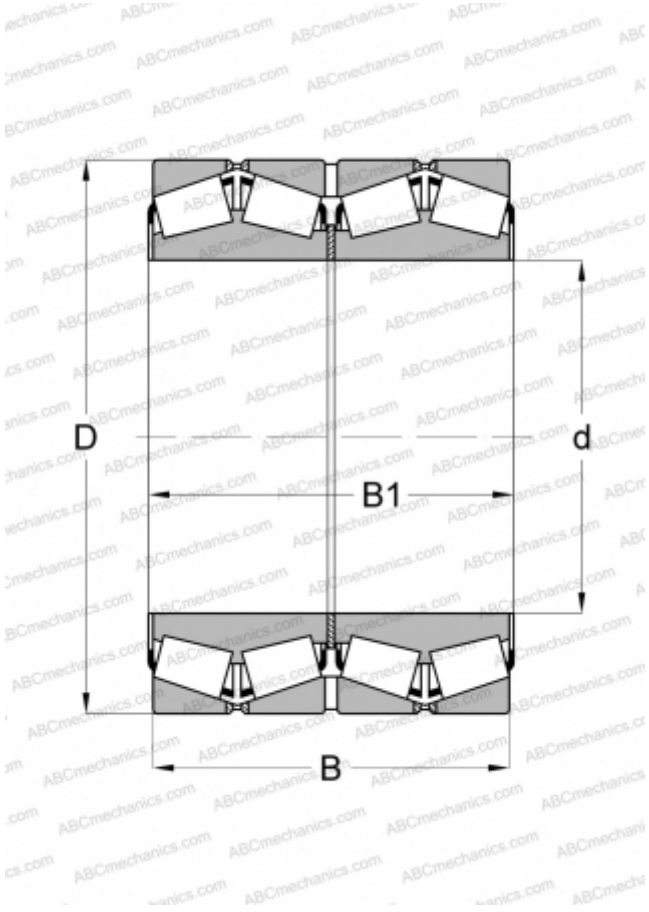

### Technical specification

#### DIMENSIONS, MM

d	203,200
D	317,500
B	266,700
B1	266,700

#### WEIGHT, KG

81,000

#### MANUFACTURER

[FAG](#)

#### INTERCHANGE

TIMKEN	<a href="#">93800DW.125.127D</a>
--------	----------------------------------