

564027 FAG

Tapered roller bearings

TYPE: Roller bearings, Tapered, Four row, Inch size, design 1 (FAG)

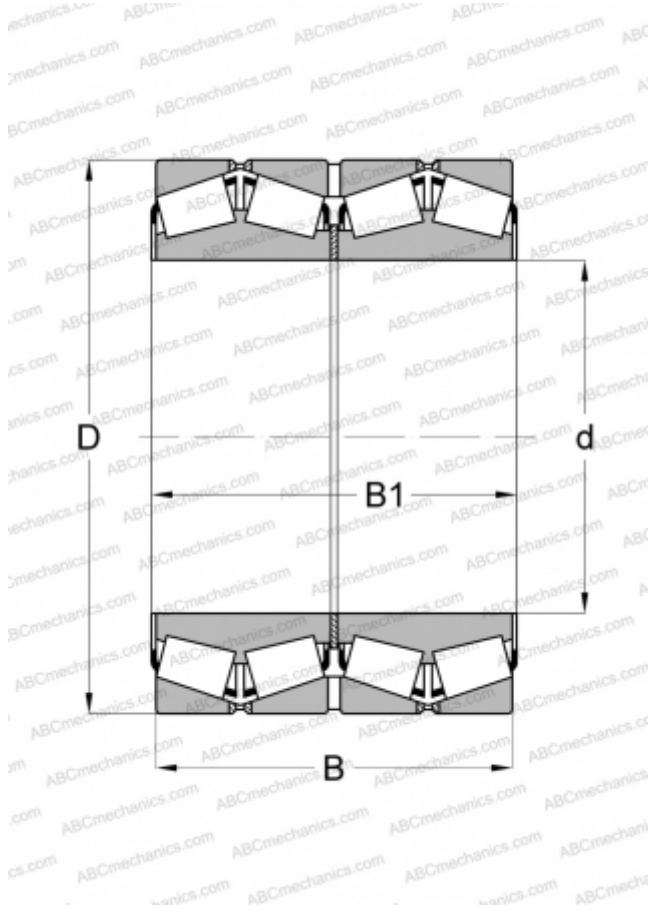

Technical specification

DIMENSIONS, MM

d	241,224
D	355,498
B	228,600
B1	228,600

WEIGHT, KG

80,000

MANUFACTURER

[FAG](#)

INTERCHANGE

TIMKEN

[EE127094DW.138.139D](#)