

802252 FAG

Tapered roller bearings

TYPE: Roller bearings, Tapered, Four row, Inch size, design 1 (FAG)

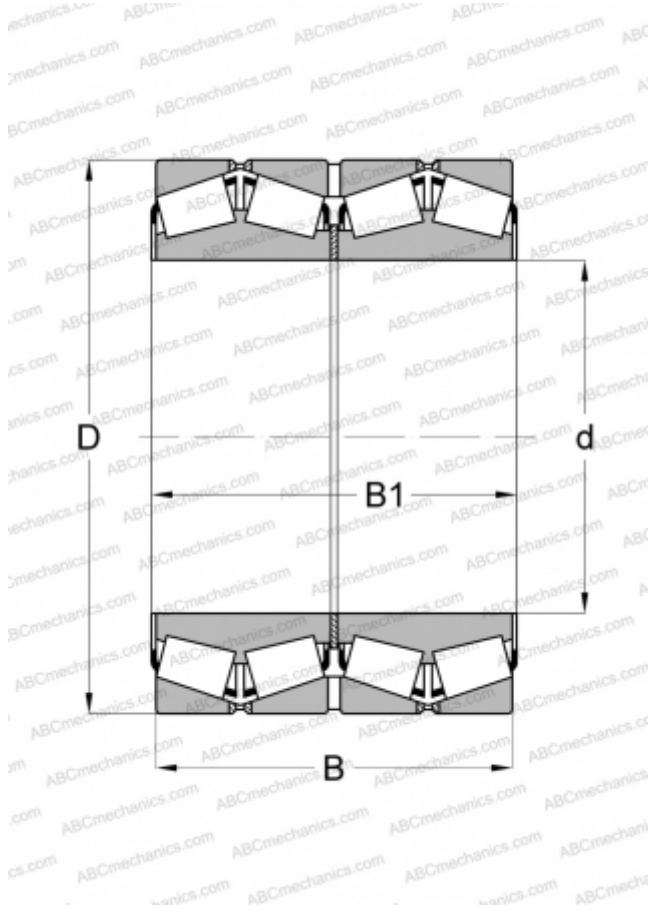

Technical specification

DIMENSIONS, MM

d	254,000
D	358,775
B	269,875
B1	269,875

WEIGHT, KG

86,000

MANUFACTURER

[FAG](#)

INTERCHANGE

TIMKEN

[M249748DW.710.710D](#)