

802010 FAG

Tapered roller bearings

TYPE: Roller bearings, Tapered, Four row, Inch size, design 1 (FAG)

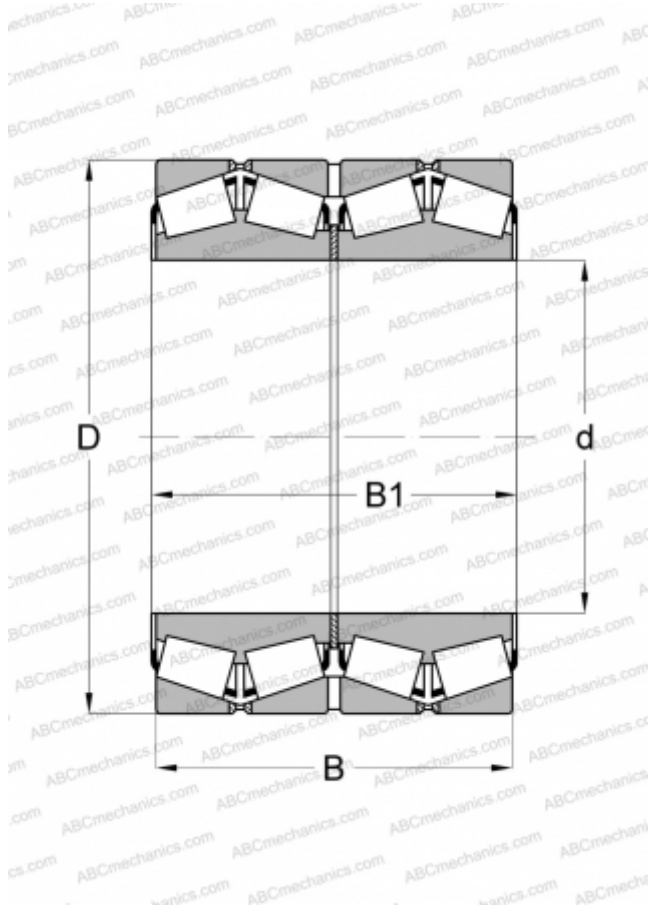

Technical specification

DIMENSIONS, MM

d	266,700
D	355,600
B	228,600
B1	230,188

WEIGHT, KG

62,000

MANUFACTURER

[FAG](#)

INTERCHANGE

TIMKEN

[LM451349DW.310.310D](#)