

802009 FAG

Tapered roller bearings

TYPE: Roller bearings, Tapered, Four row, Inch size, design 1 (FAG)

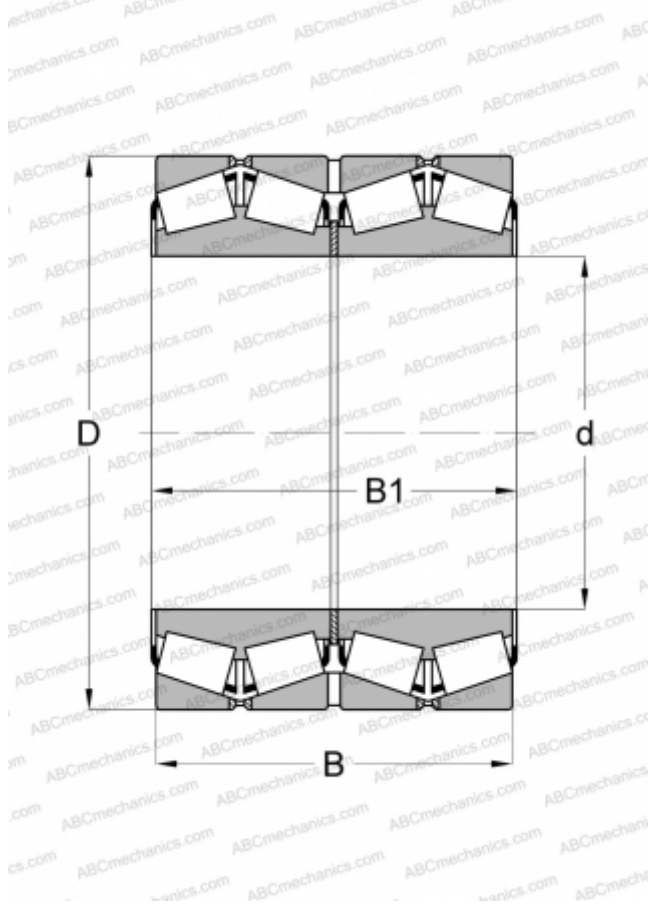

Technical specification

DIMENSIONS, MM

d	279,400
D	393,700
B	269,875
B1	269,875

WEIGHT, KG

100,000

MANUFACTURER

[FAG](#)

INTERCHANGE

TIMKEN

[EE135111DW.155.156D](#)