

512630 FAG

Tapered roller bearings

TYPE: Roller bearings, Tapered, Four row, Inch size, design 1 (FAG)

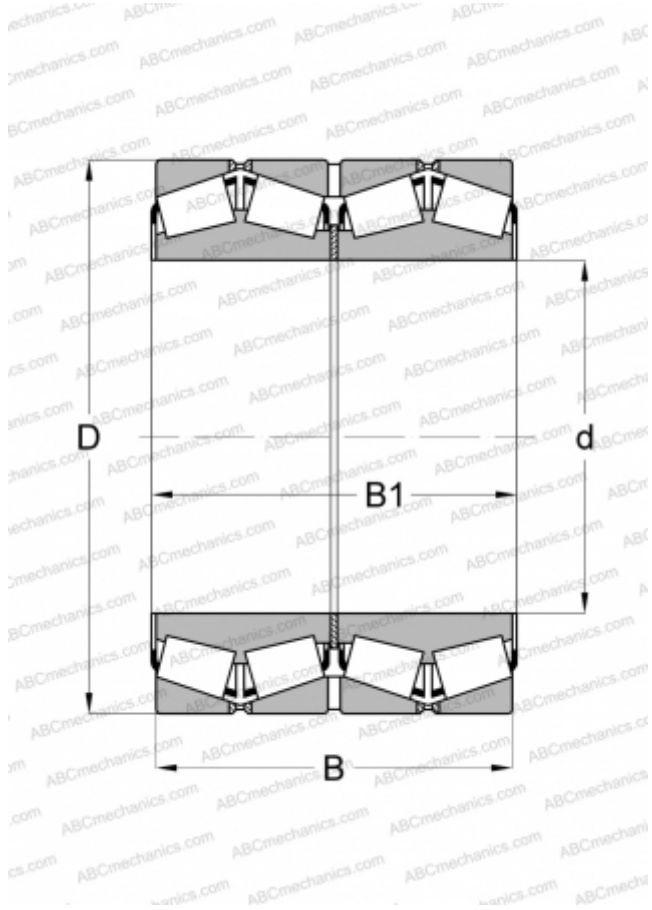

Technical specification

DIMENSIONS, MM

d	292,100
D	422,275
B	269,875
B1	269,875

WEIGHT, KG

123,000

MANUFACTURER

[FAG](#)

INTERCHANGE

TIMKEN

[EE330116DW.166.167D](#)