

## 518078 FAG

Tapered roller bearings

TYPE: Roller bearings, Tapered, Four row, Inch size, design 1 (FAG)

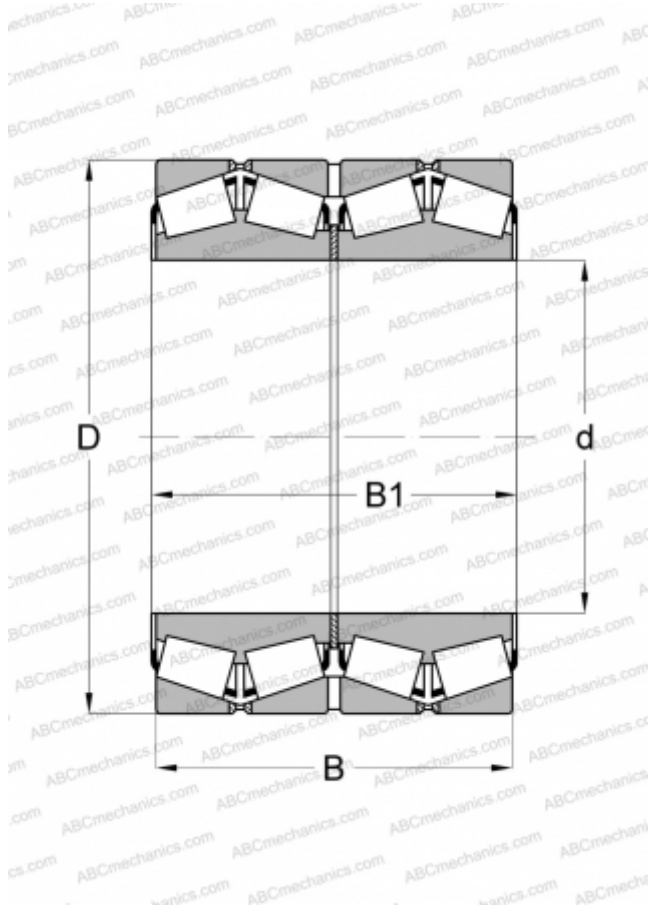

### Technical specification

#### DIMENSIONS, MM

d	305,003
D	438,048
B	279,400
B1	280,990

#### WEIGHT, KG

131,000

#### MANUFACTURER

[FAG](#)

#### INTERCHANGE

TIMKEN

[M757449DW.410.410D](#)