

802177 FAG

Tapered roller bearings

TYPE: Roller bearings, Tapered, Four row, Inch size, design 1 (FAG)

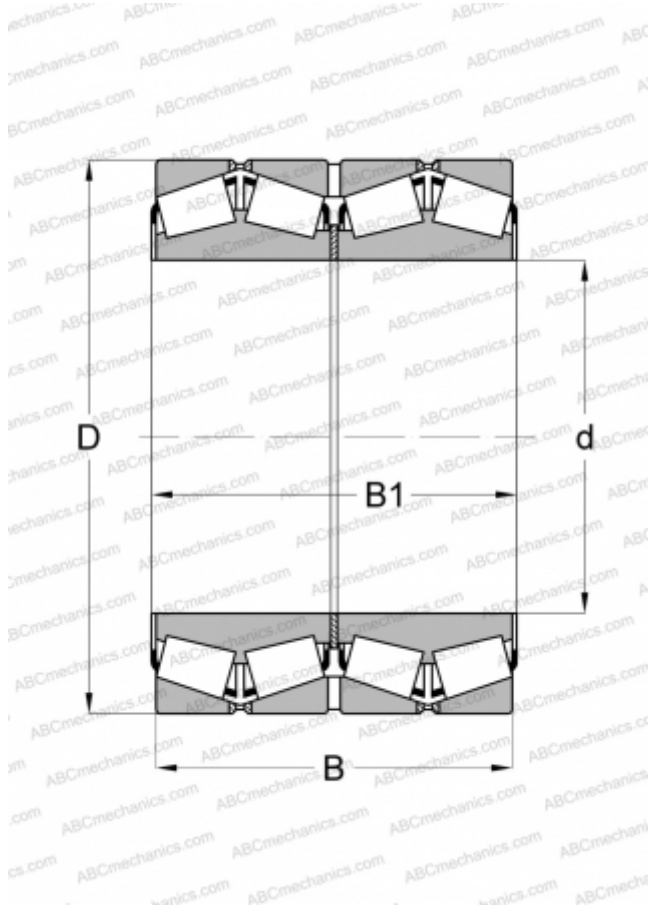

Technical specification

DIMENSIONS, MM

d	374,650
D	501,650
B	260,350
B1	250,825

WEIGHT, KG

145,000

MANUFACTURER

[FAG](#)

INTERCHANGE

TIMKEN

[LM765149DW.110.110D](#)