

511569 FAG

Tapered roller bearings

TYPE: Roller bearings, Tapered, Four row, Inch size, design 1 (FAG)

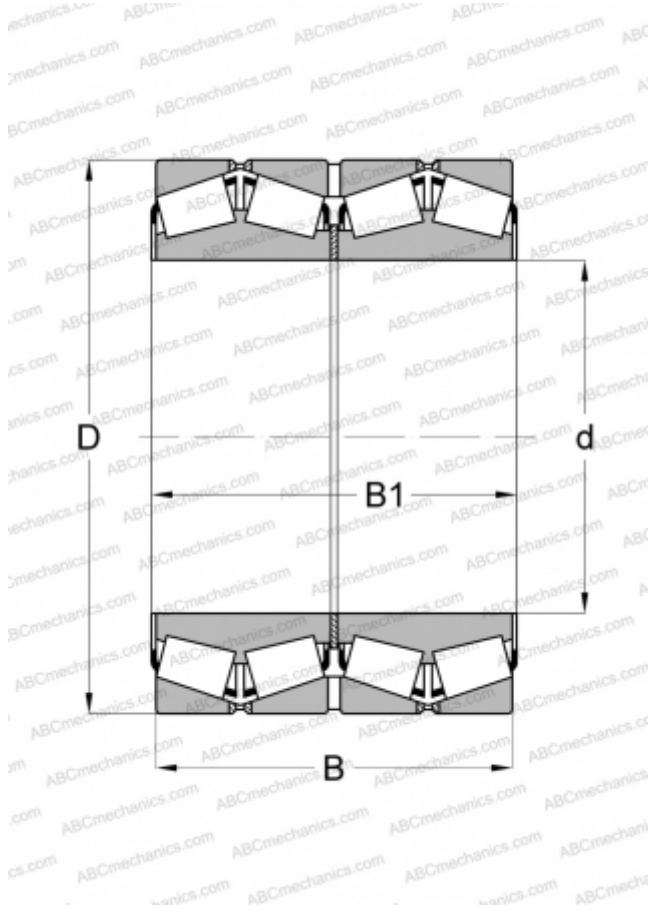

Technical specification

DIMENSIONS, MM

d	406,400
D	590,550
B	400,050
B1	400,050

WEIGHT, KG

367,000

MANUFACTURER

[FAG](#)

INTERCHANGE

TIMKEN

[EE833161DW.232.233D](#)