

802155 FAG

Tapered roller bearings

TYPE: Roller bearings, Tapered, Four row, Inch size, design 1 (FAG)

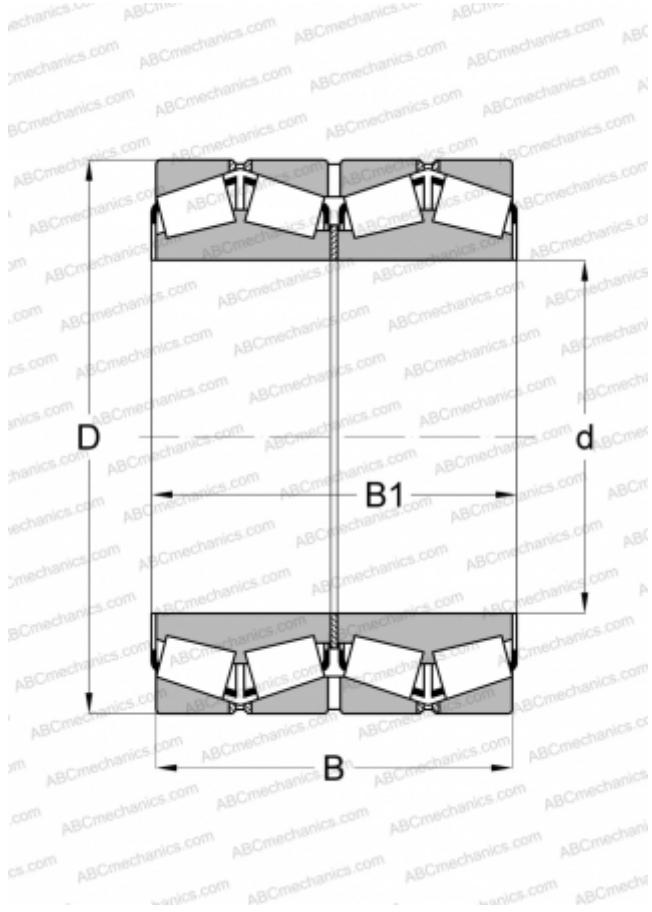

Technical specification

DIMENSIONS, MM

d	431,800
D	571,500
B	279,400
B1	279,400

WEIGHT, KG

185,000

MANUFACTURER

[FAG](#)

INTERCHANGE

TIMKEN

[LM869449DW.410.410D](#)