

## 802208 FAG

Tapered roller bearings

TYPE: Roller bearings, Tapered, Four row, Inch size, design 1 (FAG)

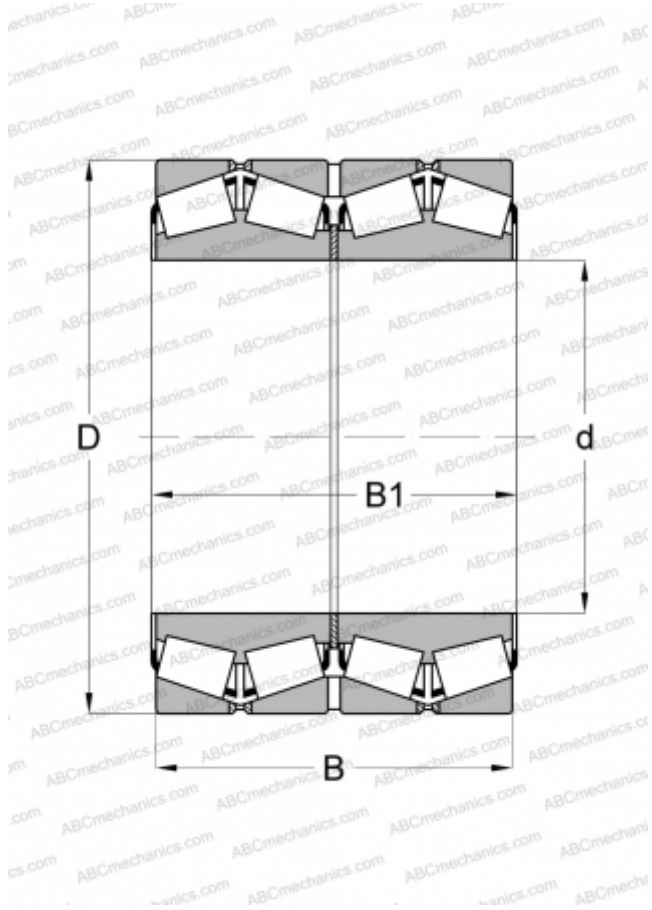

### Technical specification

#### DIMENSIONS, MM

d	460,000
D	625,000
B	421,000
B1	421,000

#### WEIGHT, KG

370,000

#### MANUFACTURER

[FAG](#)

#### INTERCHANGE

TIMKEN

[M271149DW.110.110D](#)