

## 802149 FAG

Tapered roller bearings

TYPE: Roller bearings, Tapered, Four row, With integrated seals, design 3 (FAG)

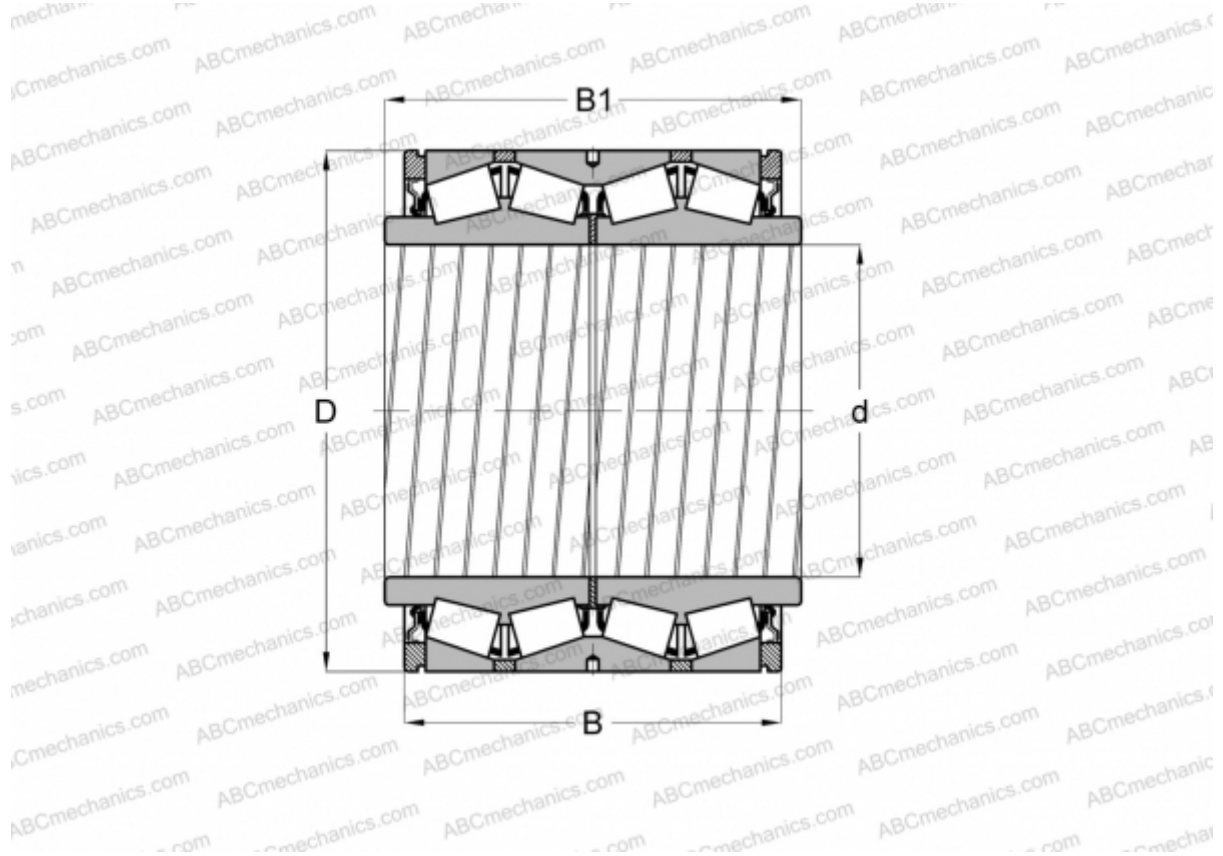

### Technical specification

#### DIMENSIONS, MM

d	482,600
D	615,950
B	377,825
B1	406,400

**WEIGHT, KG** 273,000

**MANUFACTURER** [FAG](#)