

564537 FAG

Tapered roller bearings

TYPE: Roller bearings, Tapered, Four row, With integrated seals, design 3 (FAG)

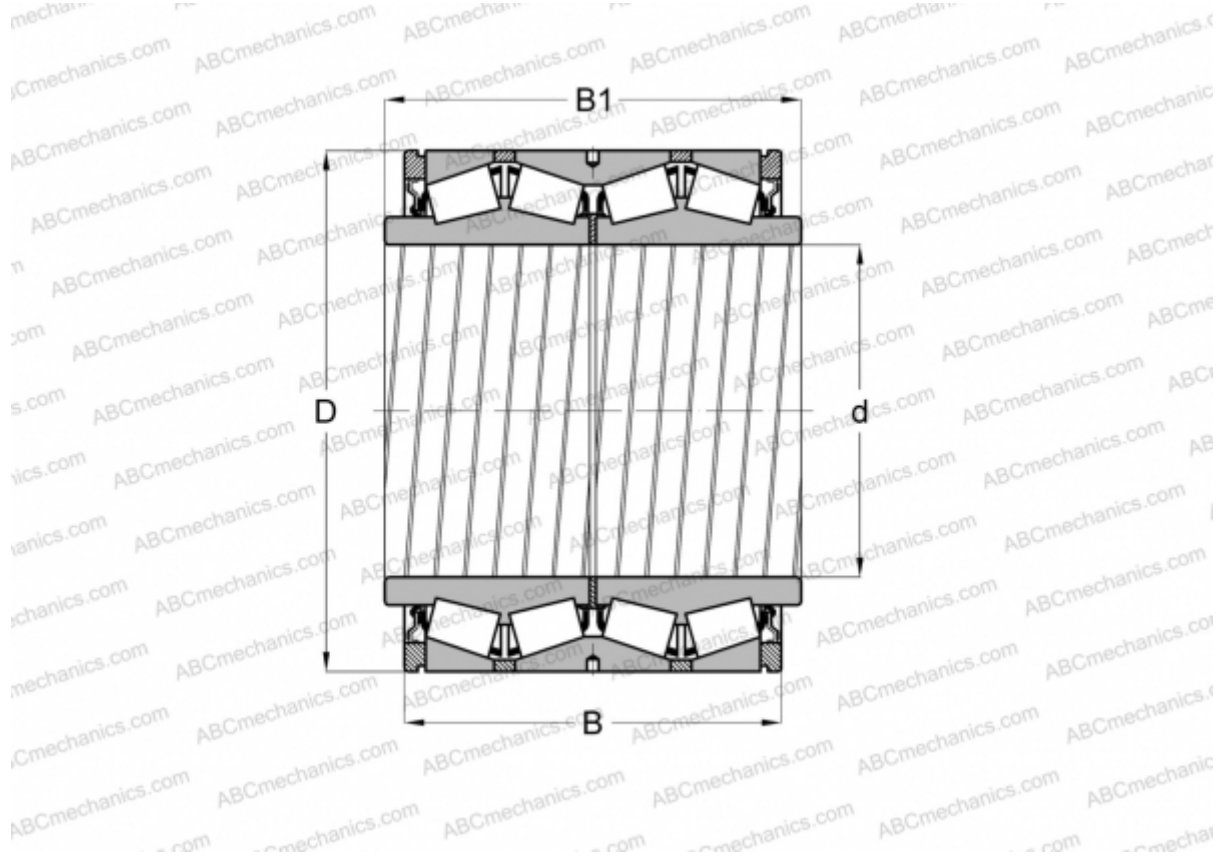

Technical specification

DIMENSIONS, MM

d	482,600
D	615,950
B	330,200
B1	419,100

WEIGHT, KG 247,000

MANUFACTURER [FAG](#)