

## 567922 FAG

Tapered roller bearings

TYPE: Roller bearings, Tapered, Four row, With integrated seals, design 3 (FAG)

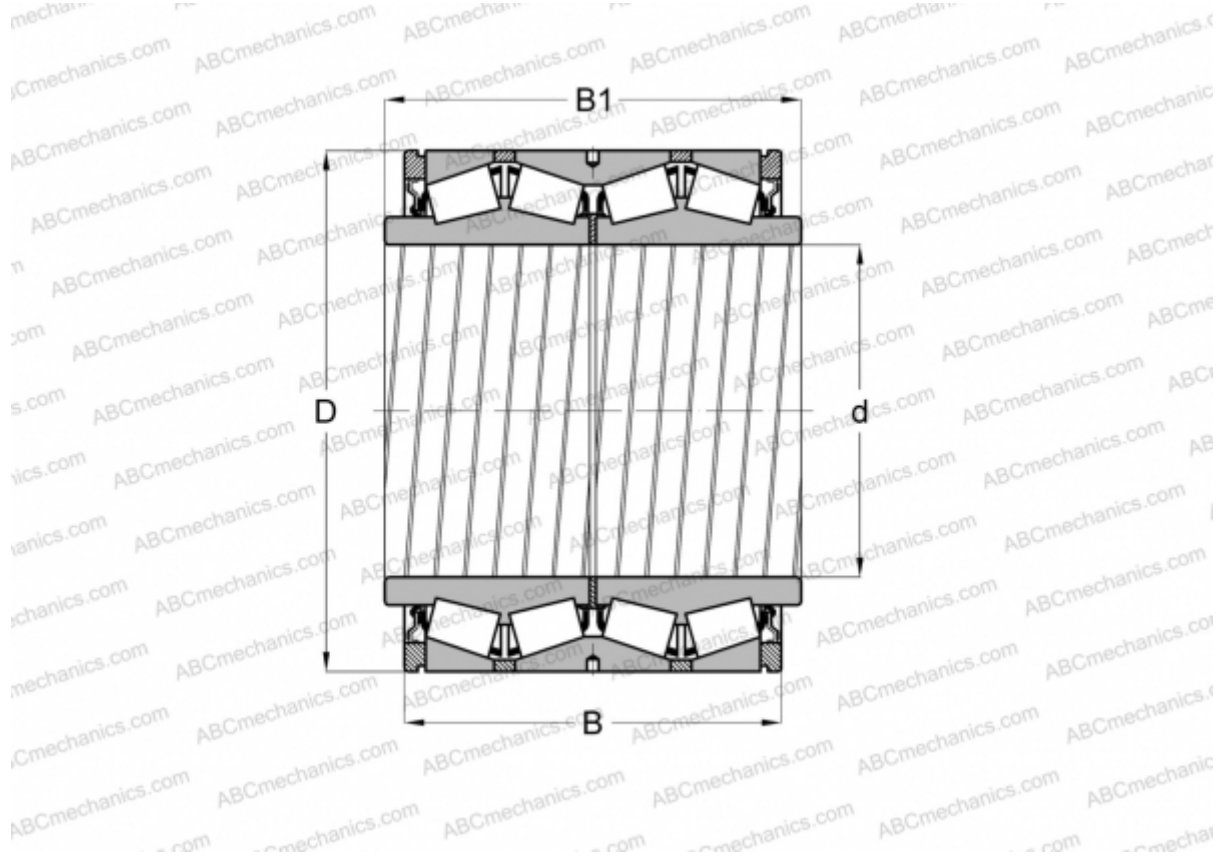

### Technical specification

#### DIMENSIONS, MM

d	711,200
D	914,400
B	317,500
B1	425,450

**WEIGHT, KG** 575,000

**MANUFACTURER** [FAG](#)