

802124 FAG

Tapered roller bearings

TYPE: Roller bearings, Tapered, Four row, With integrated seals, design 4 (FAG)

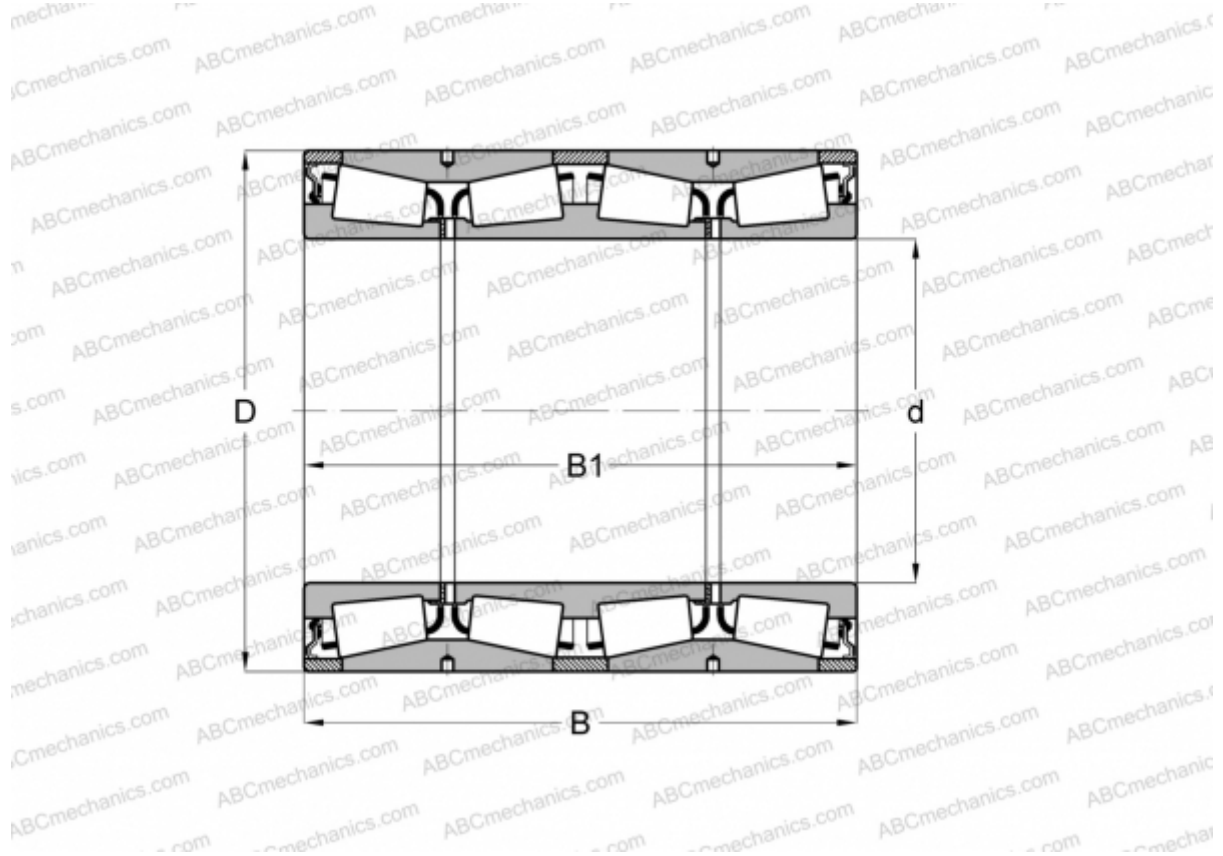

Technical specification

DIMENSIONS, MM

d	287,500
D	440,000
B	330,000
B1	330,000

WEIGHT, KG 190,000

MANUFACTURER [FAG](#)