

580269 FAG

Tapered roller bearings

TYPE: Roller bearings, Tapered, Four row, With integrated seals, design 4 (FAG)

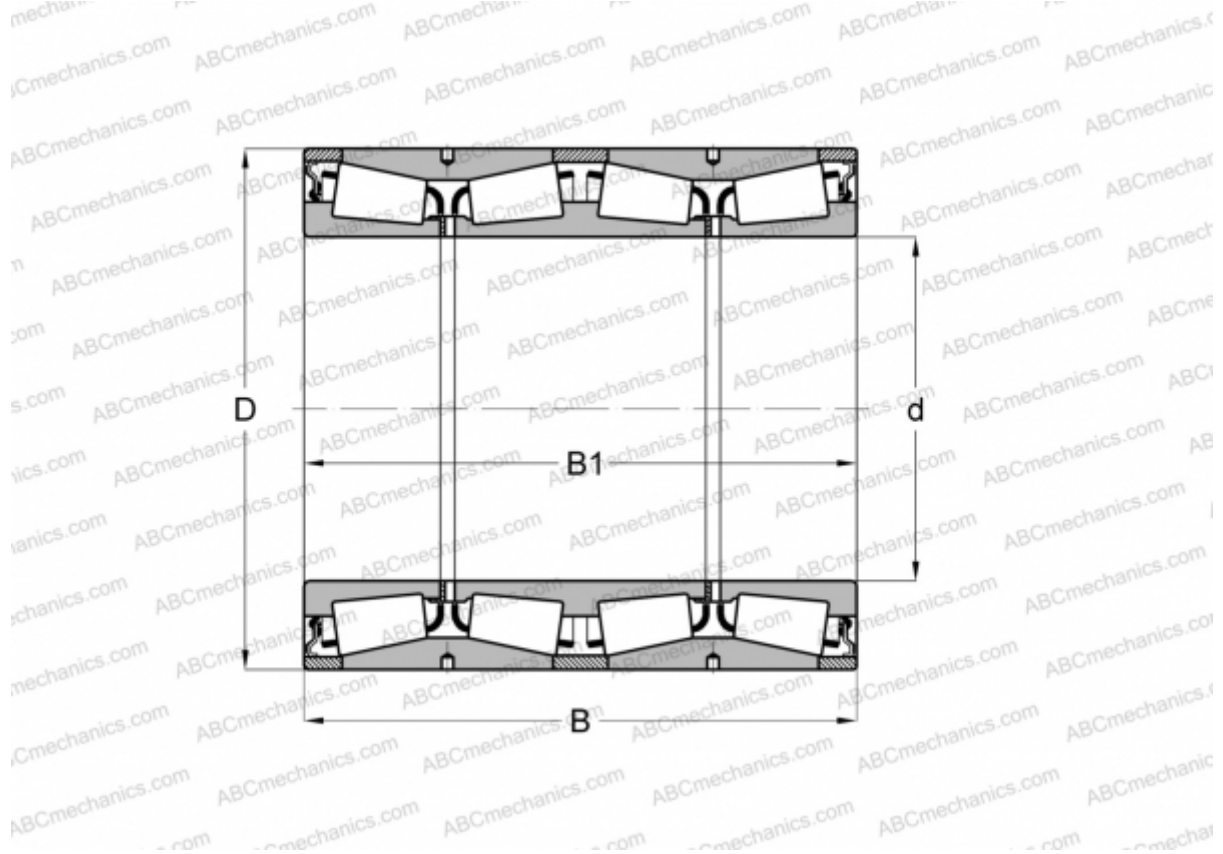

Technical specification

DIMENSIONS, MM

d	450,000
D	595,000
B	414,000
B1	414,000

WEIGHT, KG 308,000

MANUFACTURER [FAG](#)