

## 802176 FAG

Tapered roller bearings

TYPE: Roller bearings, Tapered, Four row, With extended cones (FAG)

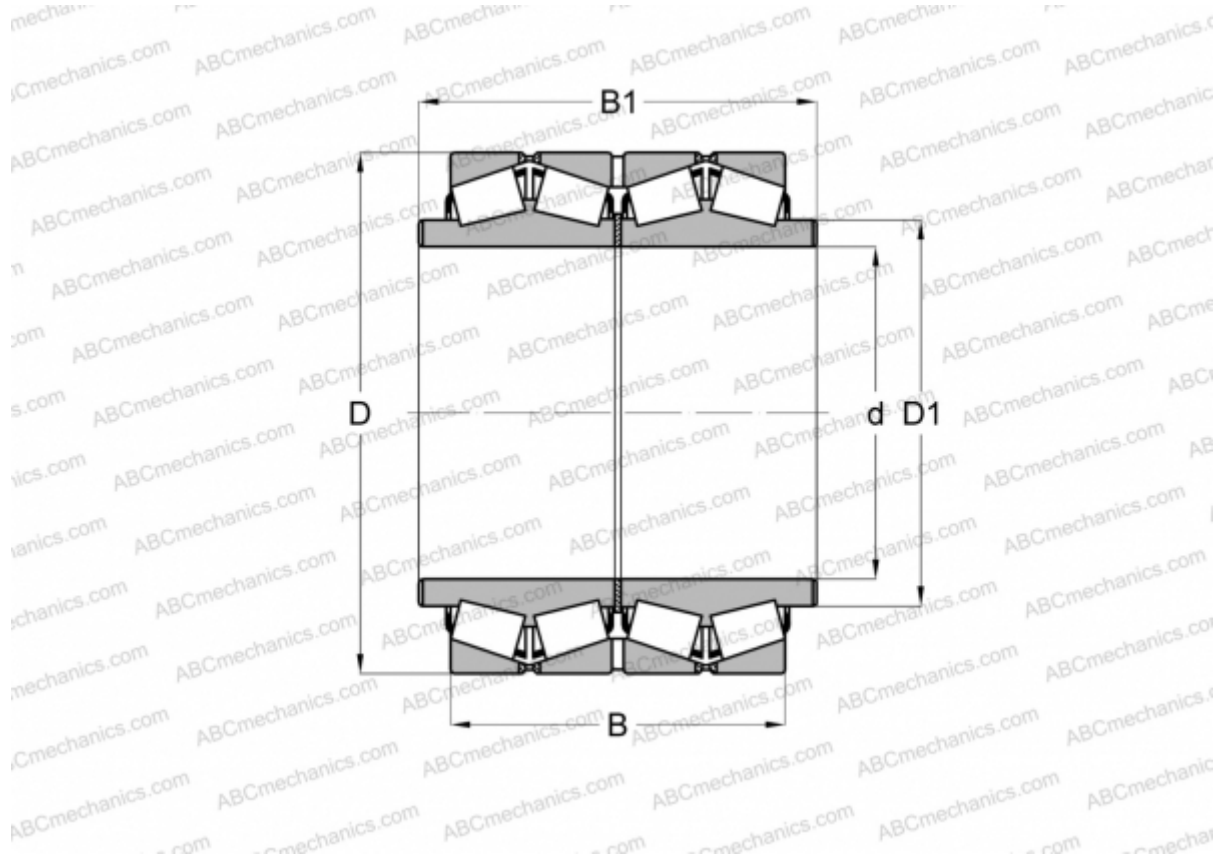

### Technical specification

#### DIMENSIONS, MM

d	273,050
D	381,000
D1	304,800
B	244,475
B1	304,800

**WEIGHT, KG** 98,000

**MANUFACTURER** [FAG](#)