

## 547044 FAG

Tapered roller bearings

TYPE: Roller bearings, Tapered, Four row, With extended cones (FAG)

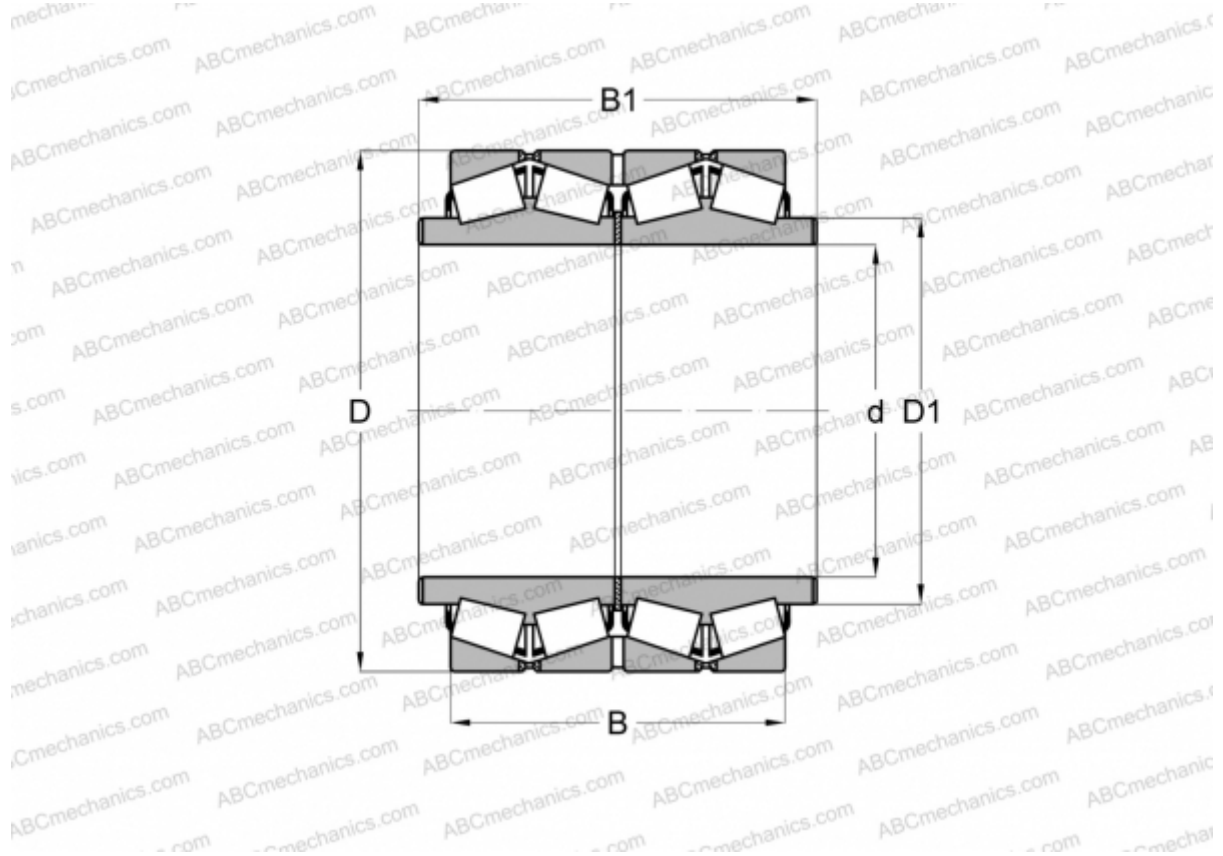

### Technical specification

#### DIMENSIONS, MM

d	279,578
D	380,898
D1	304,800
B	244,475
B1	304,800

**WEIGHT, KG** 89,500

**MANUFACTURER** [FAG](#)