

522458 FAG

Tapered roller bearings

TYPE: Roller bearings, Tapered, Four row, With extended cones (FAG)

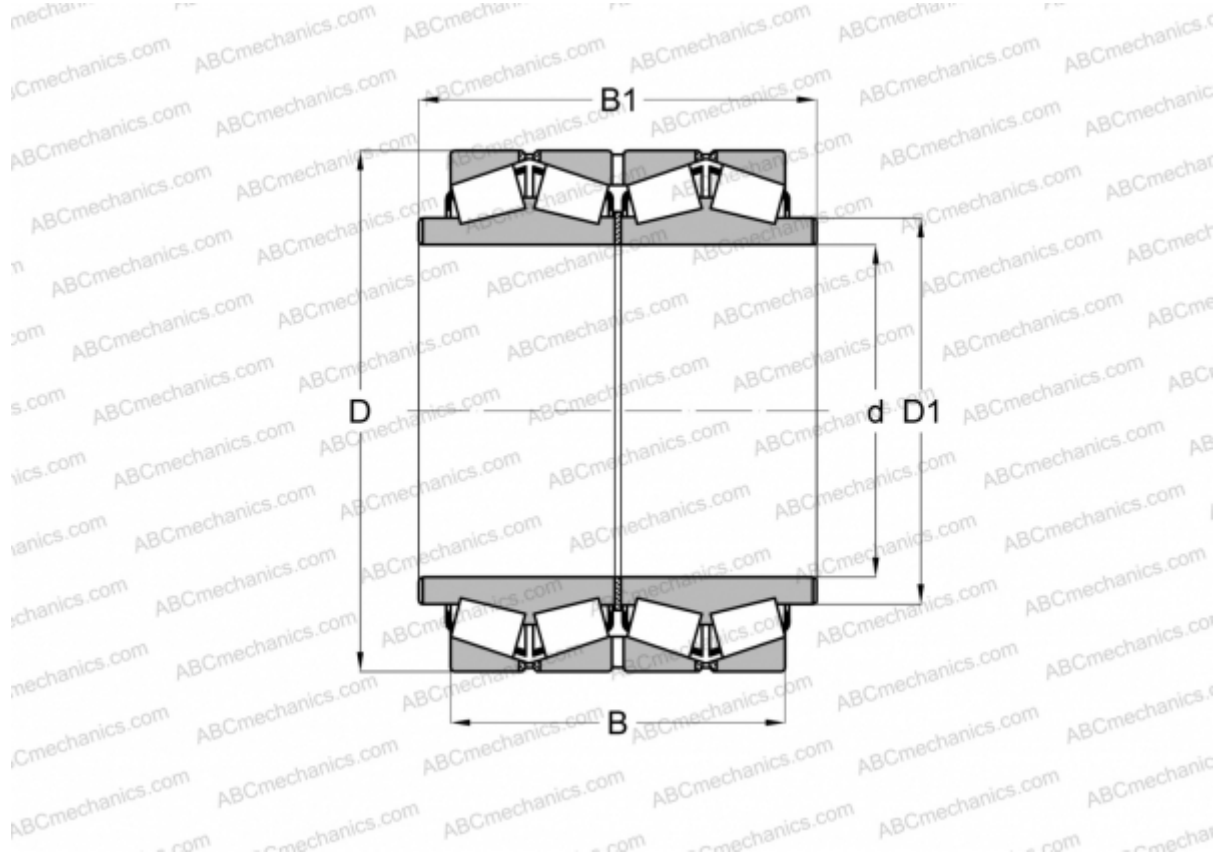

Technical specification

DIMENSIONS, MM

d	285,750
D	380,898
D1	300,000
B	244,475
B1	314,475

WEIGHT, KG 82,000

MANUFACTURER [FAG](#)