

547043 FAG

Tapered roller bearings

TYPE: Roller bearings, Tapered, Four row, With extended cones (FAG)

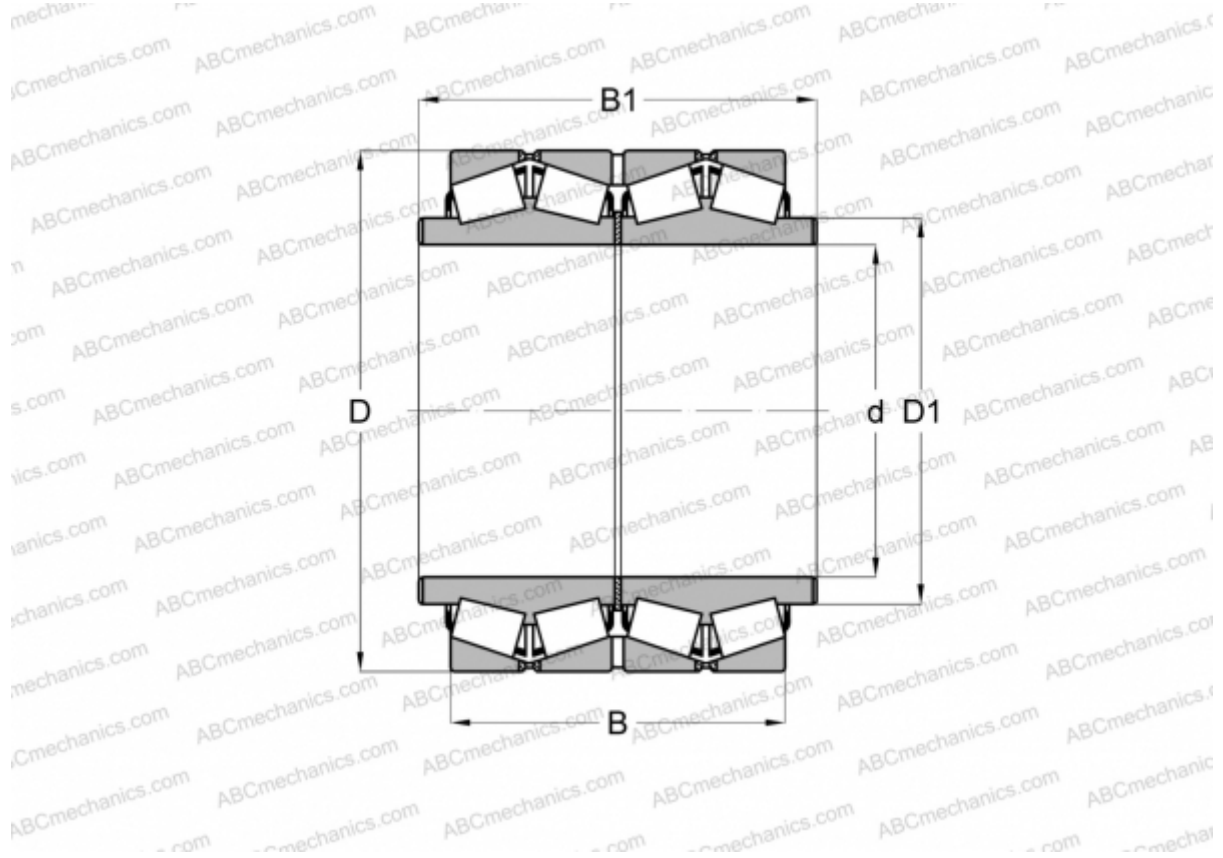

Technical specification

DIMENSIONS, MM

d	355,600
D	482,600
D1	381,000
B	269,875
B1	330,200

WEIGHT, KG 150,000

MANUFACTURER [FAG](#)