

544260 FAG

Tapered roller bearings

TYPE: Roller bearings, Tapered, Four row, With extended cones (FAG)

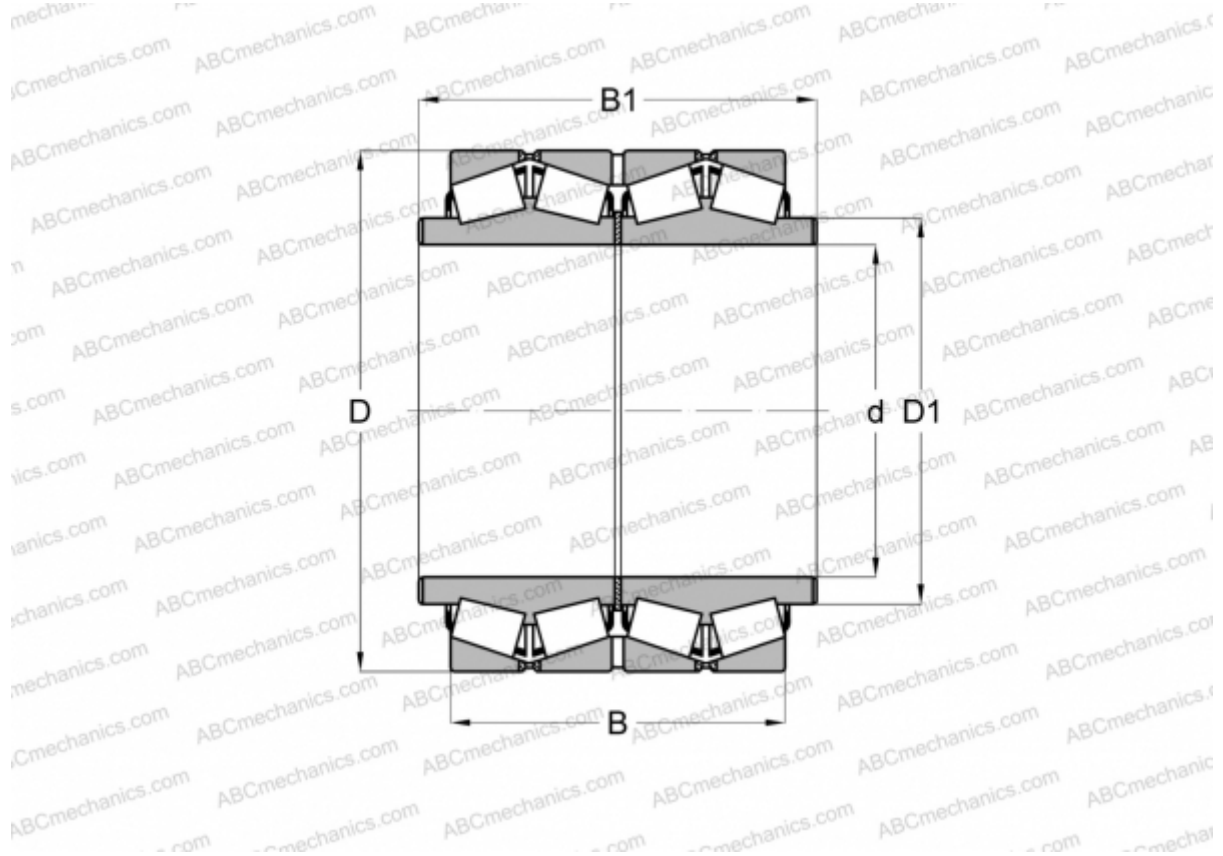

Technical specification

DIMENSIONS, MM

d	355,600
D	488,950
D1	381,000
B	317,500
B1	381,000

WEIGHT, KG 190,000

MANUFACTURER [FAG](#)