

548232 FAG

Tapered roller bearings

TYPE: Roller bearings, Tapered, Four row, With extended cones (FAG)

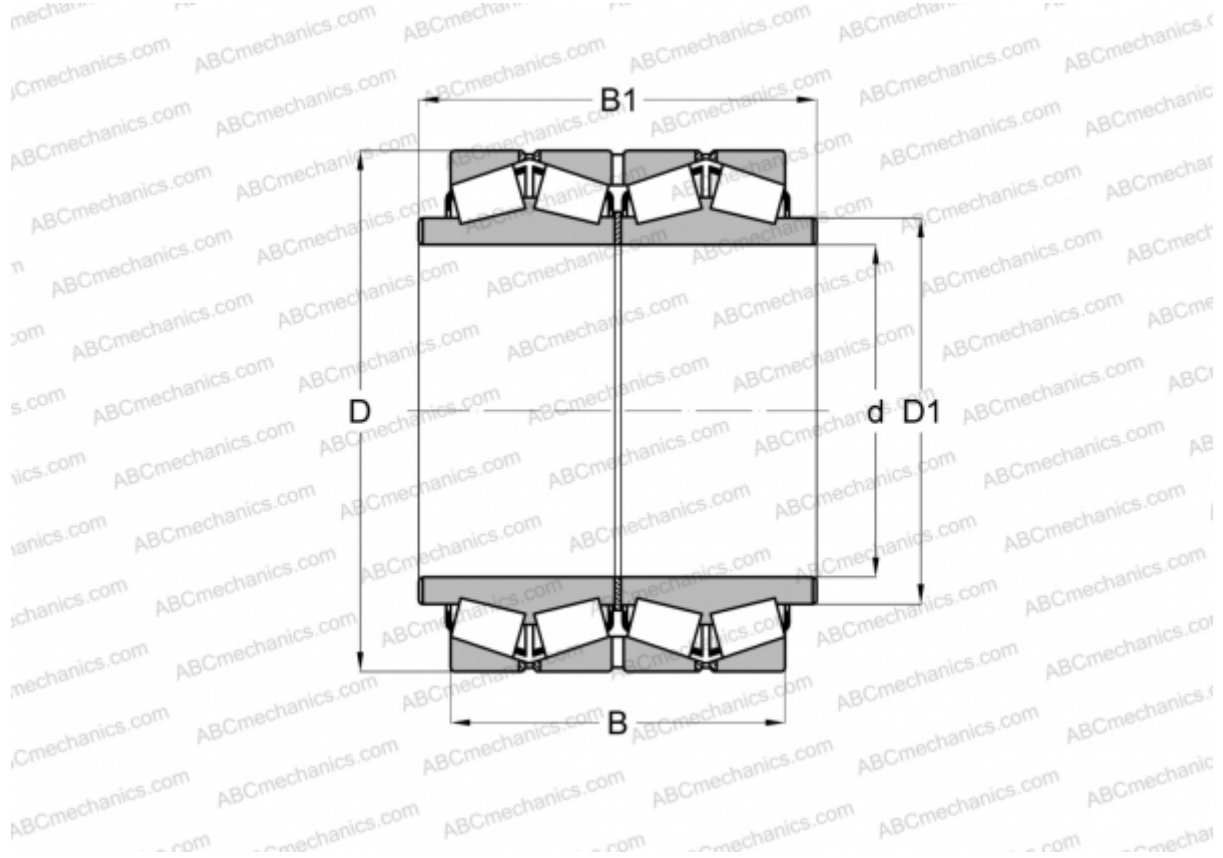

Technical specification

DIMENSIONS, MM

d	431,800
D	571,500
D1	454,025
B	336,550
B1	412,750

WEIGHT, KG 245,000

MANUFACTURER [FAG](#)