

548641 FAG

Tapered roller bearings

TYPE: Roller bearings, Tapered, Four row, With extended cones (FAG)

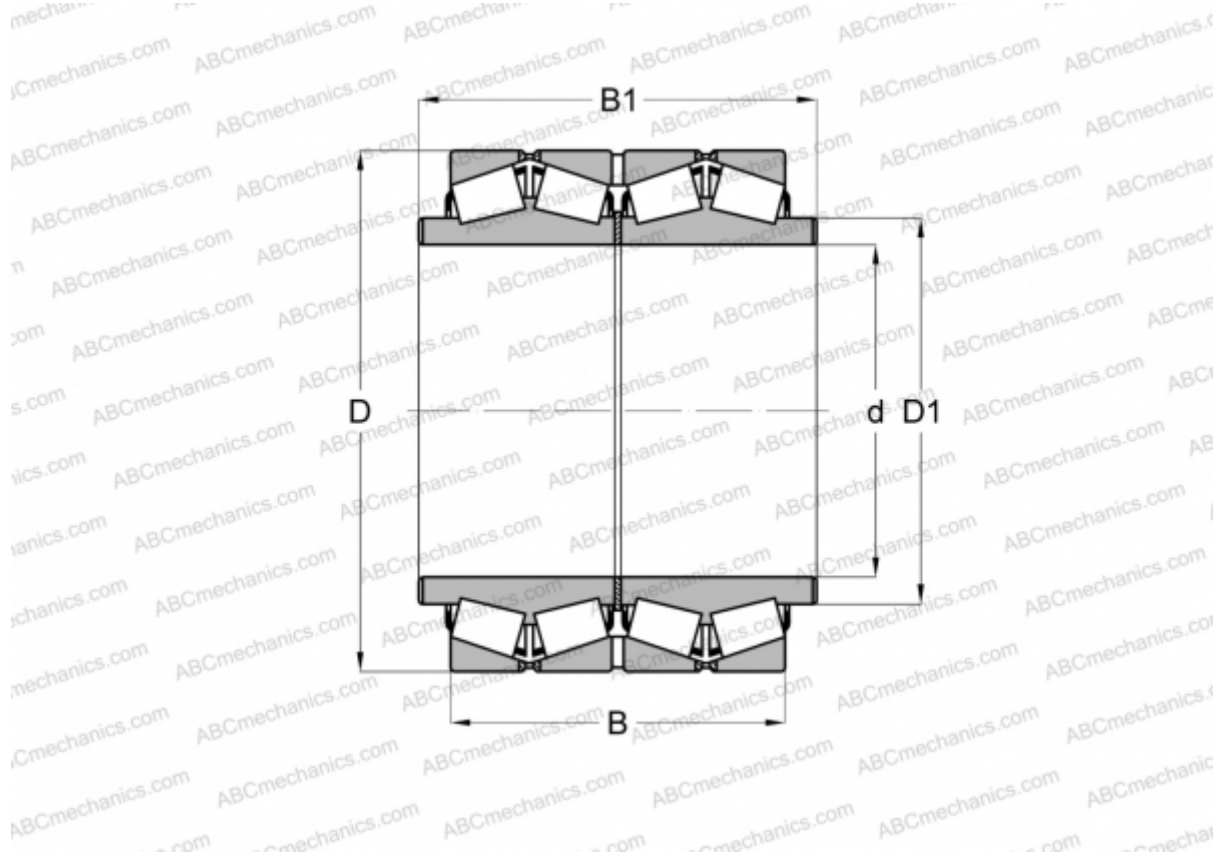

Technical specification

DIMENSIONS, MM

d	482,600
D	615,950
D1	514,350
B	330,200
B1	406,400

WEIGHT, KG 257,000

MANUFACTURER [FAG](#)