

548234 FAG

Tapered roller bearings

TYPE: Roller bearings, Tapered, Four row, With extended cones (FAG)

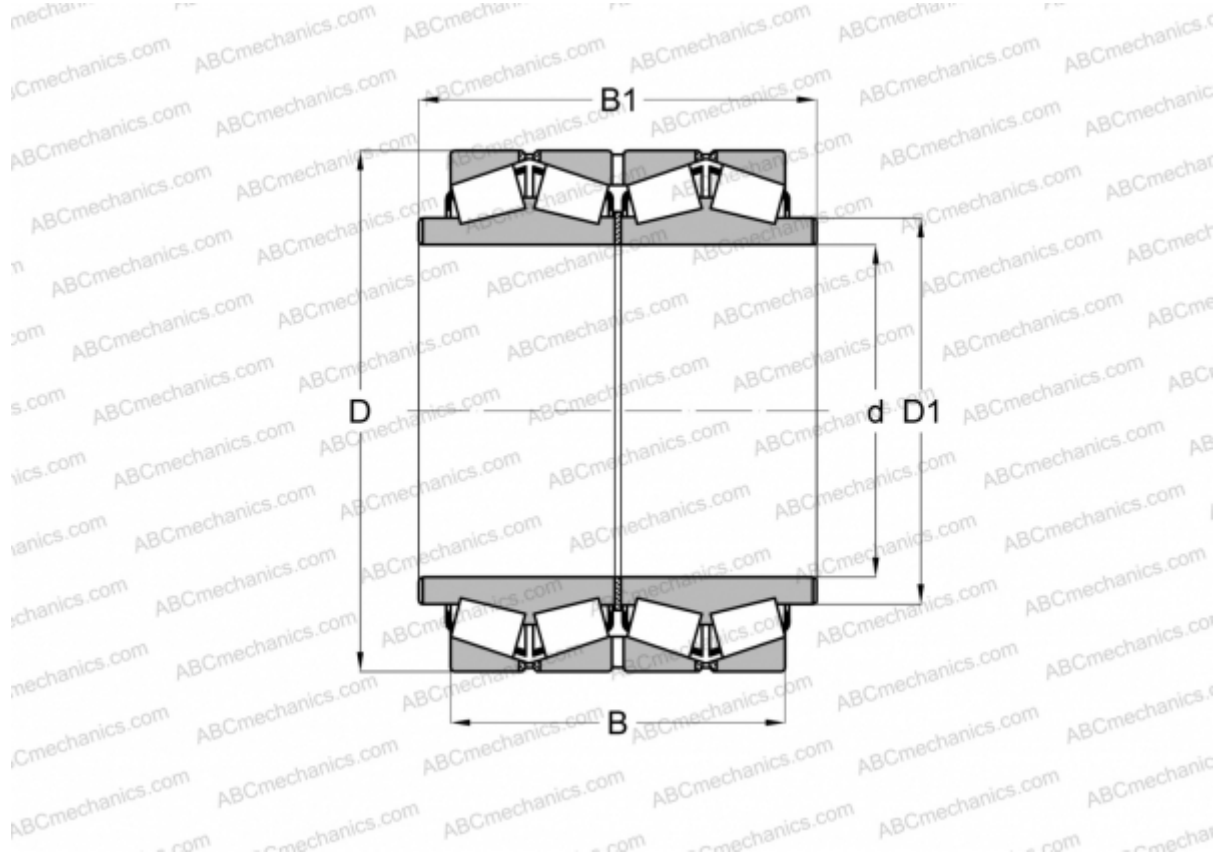

Technical specification

DIMENSIONS, MM

d	501,650
D	711,200
D1	539,750
B	520,700
B1	603,250

WEIGHT, KG 680,000

MANUFACTURER [FAG](#)