

548233 FAG

Tapered roller bearings

TYPE: Roller bearings, Tapered, Four row, With extended cones (FAG)

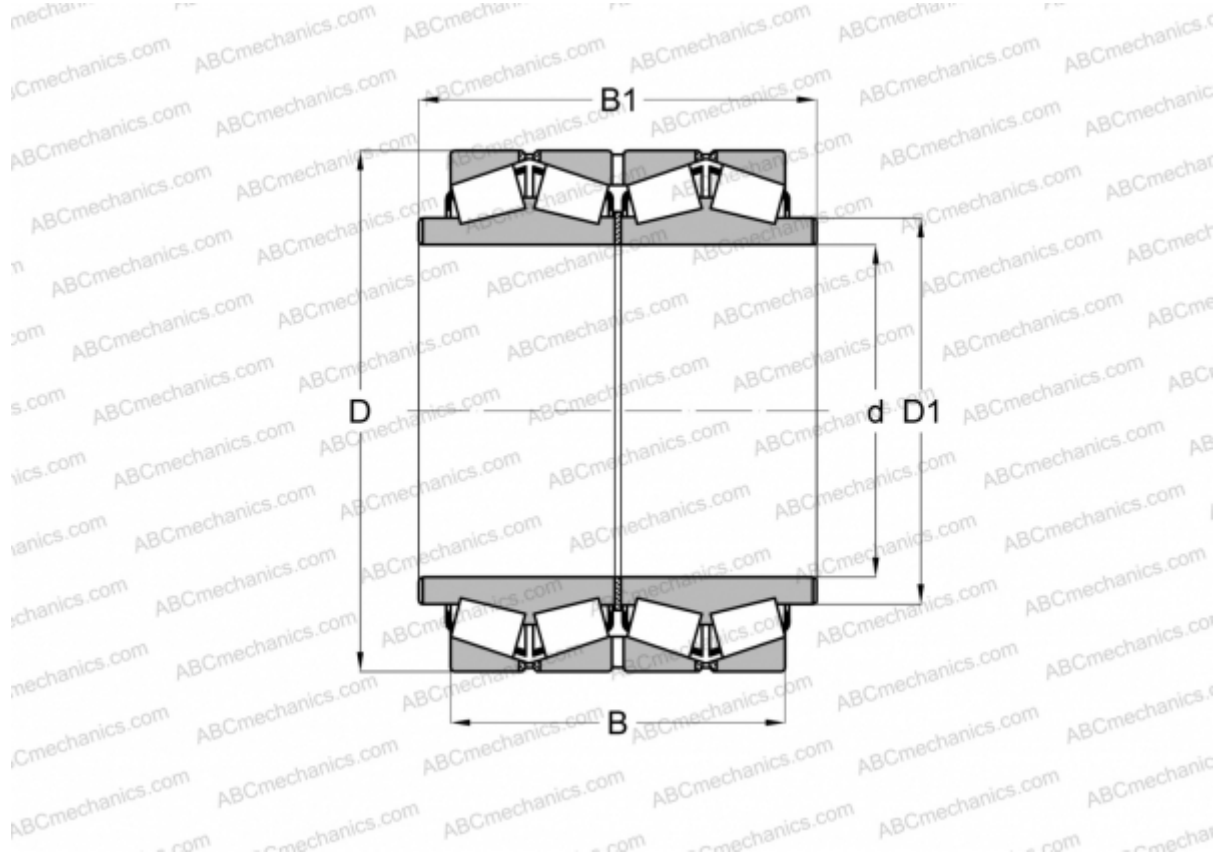

Technical specification

DIMENSIONS, MM

d	536,575
D	761,873
D1	577,850
B	558,800
B1	638,175

WEIGHT, KG 838,000

MANUFACTURER [FAG](#)