

## 561017 FAG

Tapered roller bearings

TYPE: Roller bearings, Tapered, Four row, With extended cones (FAG)

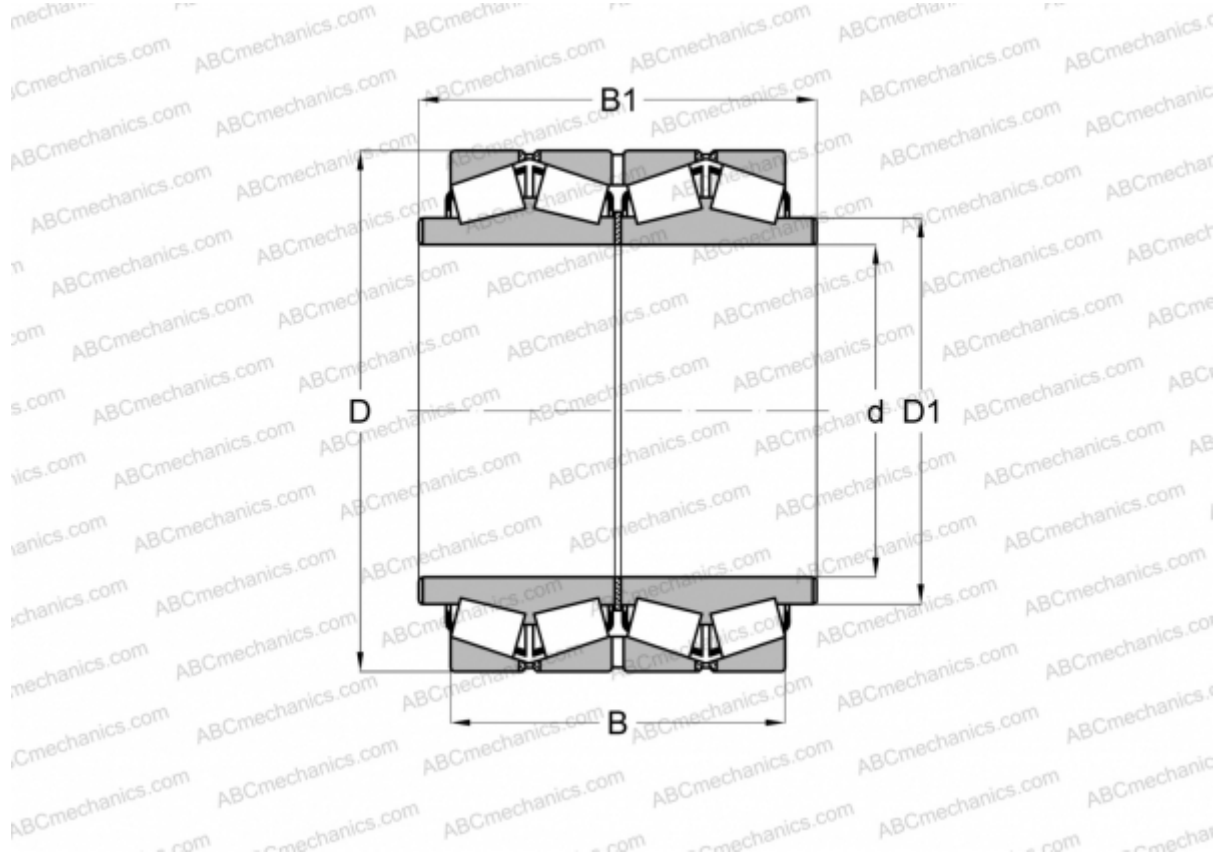

### Technical specification

#### DIMENSIONS, MM

d	585,788
D	771,525
D1	622,300
B	479,425
B1	555,625

**WEIGHT, KG** 625,000

**MANUFACTURER** [FAG](#)