

523039 FAG

Tapered roller bearings

TYPE: Roller bearings, Tapered, Four row, With extended cones (FAG)

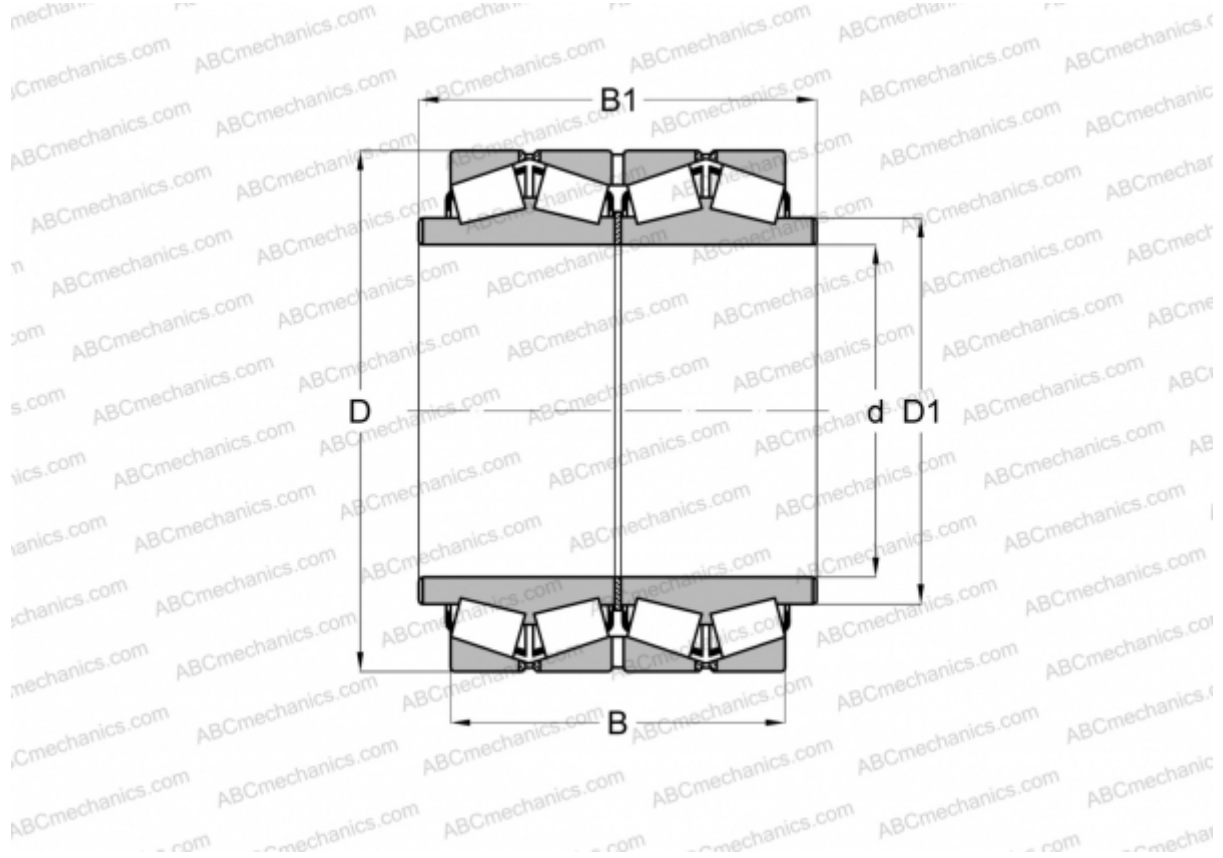

Technical specification

DIMENSIONS, MM

d	685,800
D	876,300
D1	736,600
B	355,600
B1	457,200

WEIGHT, KG 551,000

MANUFACTURER [FAG](#)