

532479 FAG

Tapered roller bearings

TYPE: Roller bearings, Tapered, Four row, With extended cones (FAG)

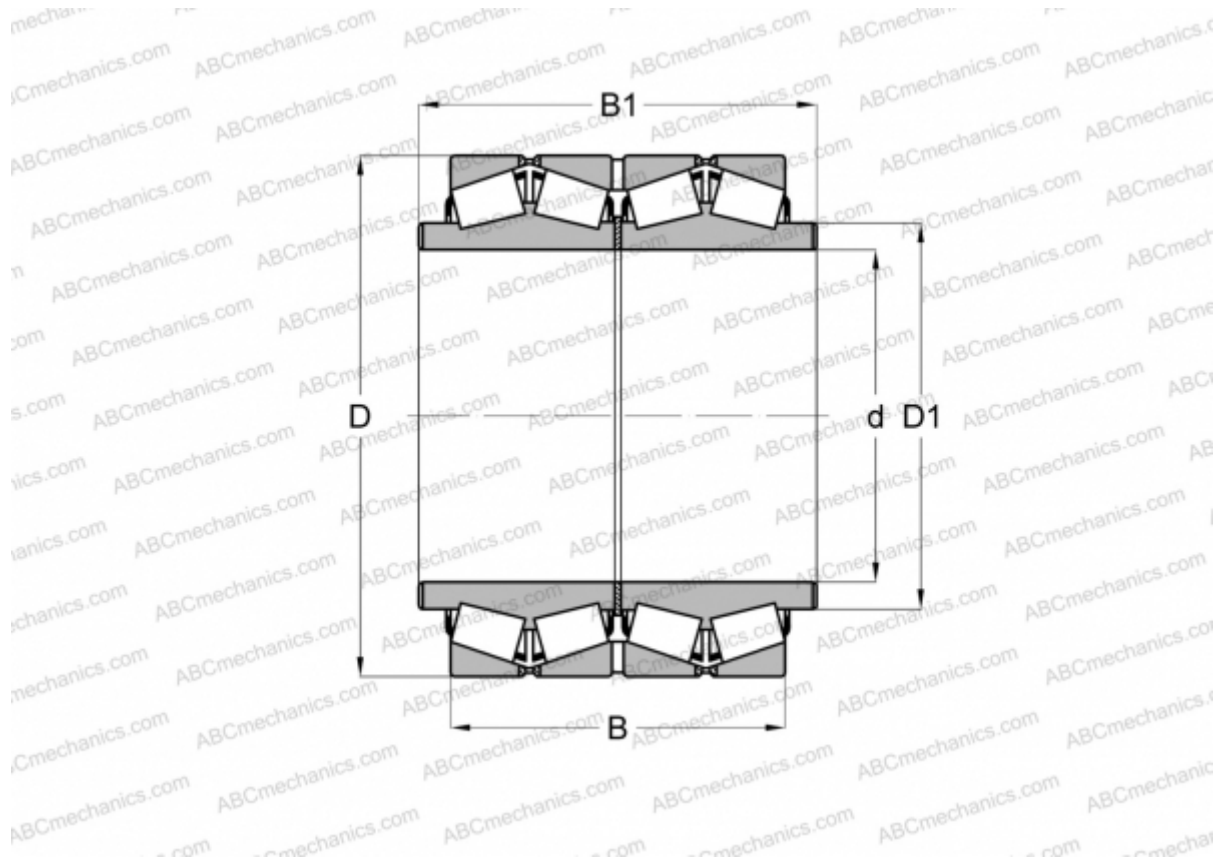

Technical specification

DIMENSIONS, MM

d	711,200
D	914,400
D1	774,700
B	317,500
B1	425,450

WEIGHT, KG 588,000

MANUFACTURER [FAG](#)