

B-8424-C TIMKEN

TYPE: Roller bearings, Tapered, Thrust, Type TTVS, self-aligning with stop rings

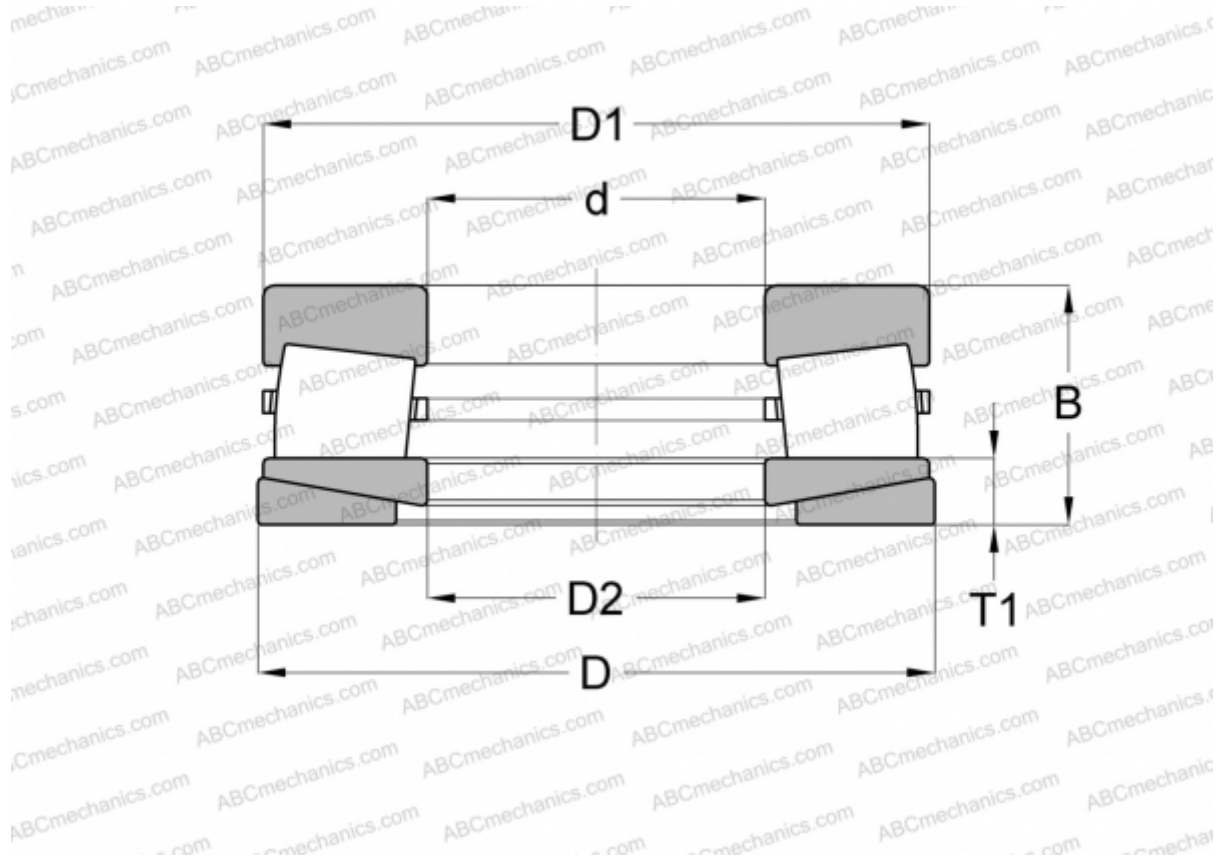

Technical specification

DIMENSIONS, MM

d	406,400
D	869,950
D1	887,410
D2	438,150
B	241,300
T1	82,550

WEIGHT, KG 858,000

MANUFACTURER [TIMKEN](#)