

543535 FAG

TYPE: Roller bearings, Tapered, Thrust, For screw down mechanisms, design 2 (FAG)

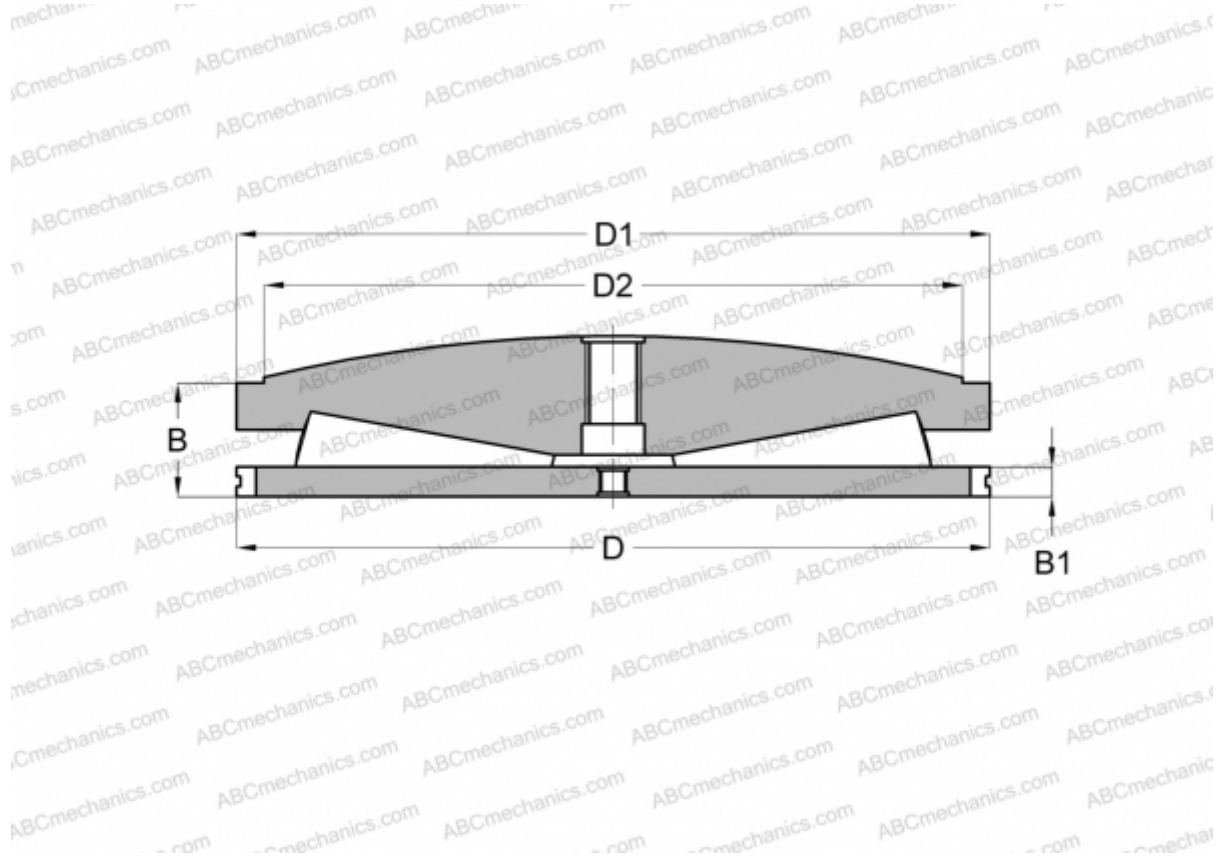

Technical specification

DIMENSIONS, MM

D	174,630
D1	172,260
D2	152,400
B	61,390
B1	12,700

WEIGHT, KG 10,000

MANUFACTURER [FAG](#)