

565775 FAG

TYPE: Roller bearings, Tapered, Thrust, For screw down mechanisms, design 2 (FAG)

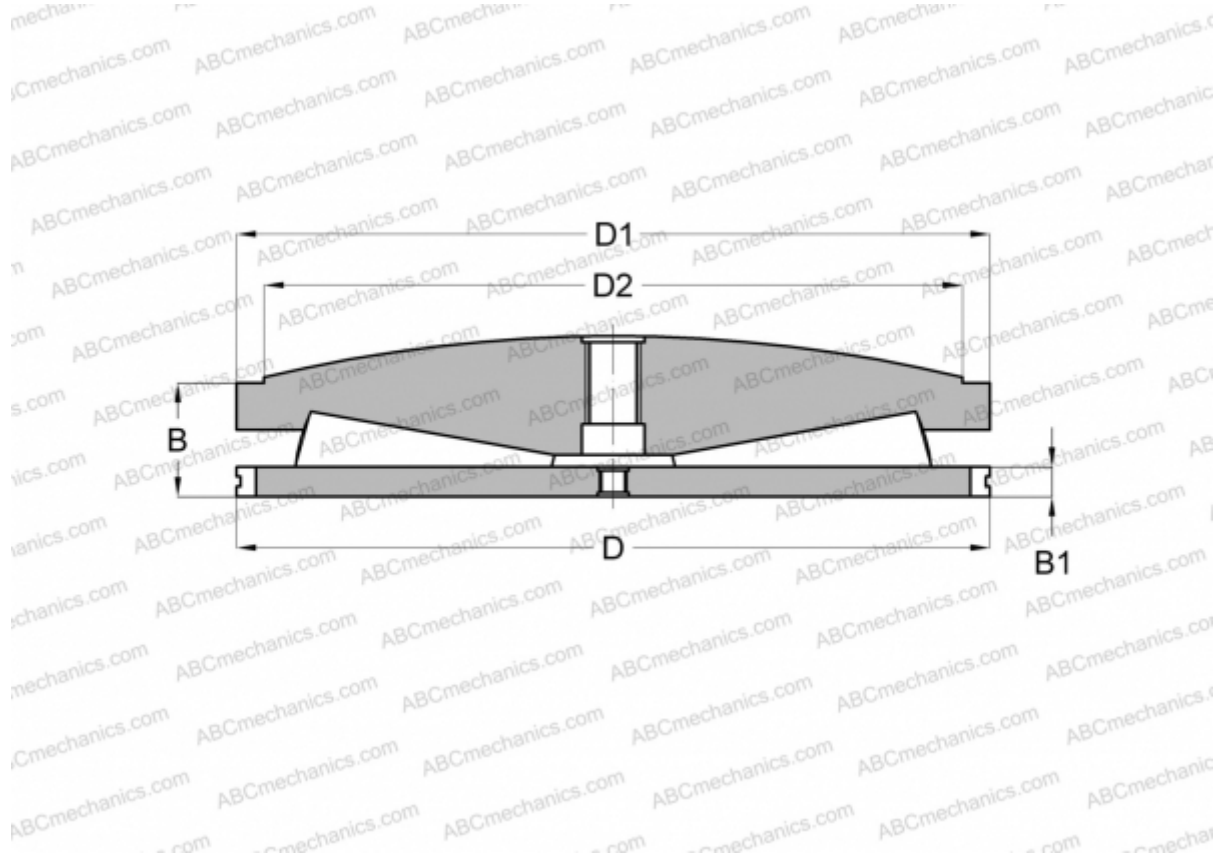

Technical specification

DIMENSIONS, MM

D	203,200
D1	200,840
D2	177,800
B	75,620
B1	15,880

WEIGHT, KG 17,000

MANUFACTURER [FAG](#)