

## 543655 FAG

TYPE: Roller bearings, Tapered, Thrust, For screw down mechanisms, design 2 (FAG)

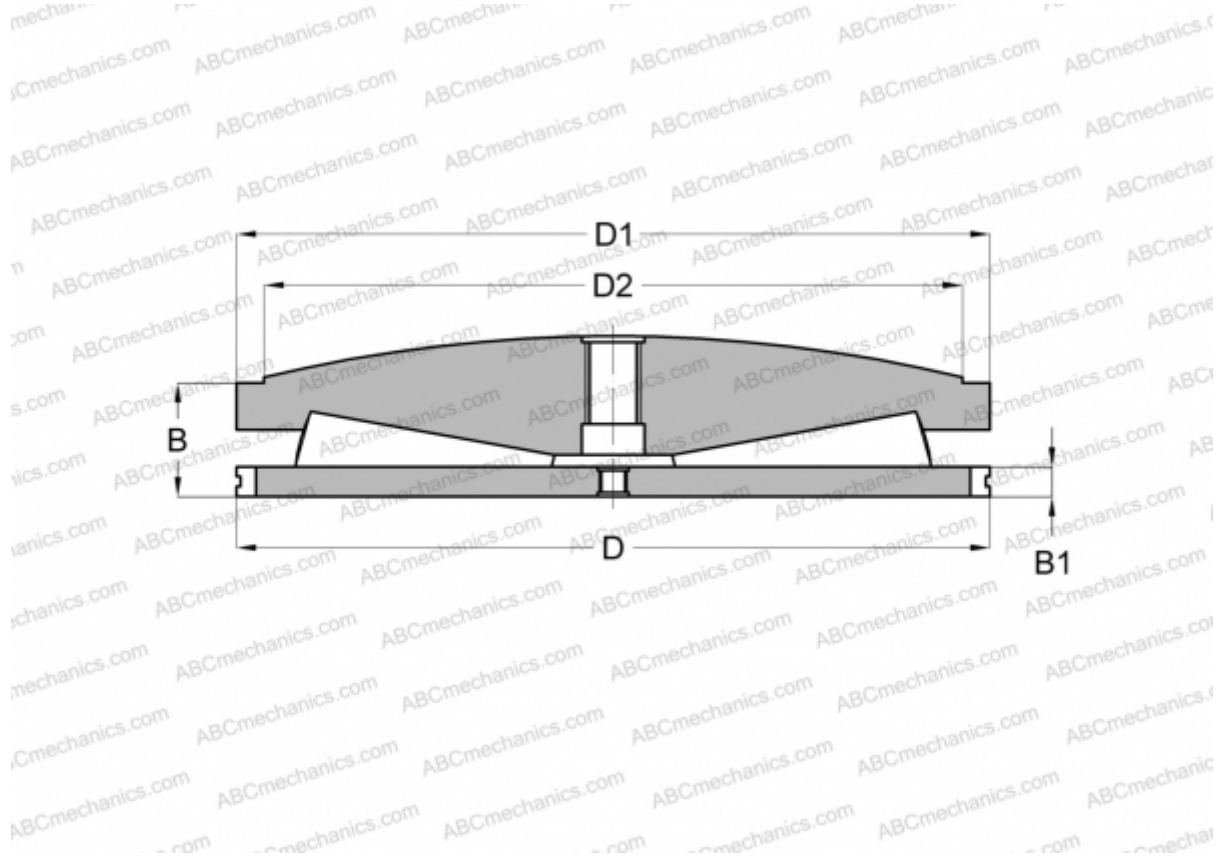

### Technical specification

#### DIMENSIONS, MM

D	215,900
D1	215,900
D2	175,000
B	74,630
B1	15,880

**WEIGHT, KG** 18,500

**MANUFACTURER** [FAG](#)