

522978 FAG

TYPE: Roller bearings, Tapered, Thrust, For screw down mechanisms, design 2 (FAG)

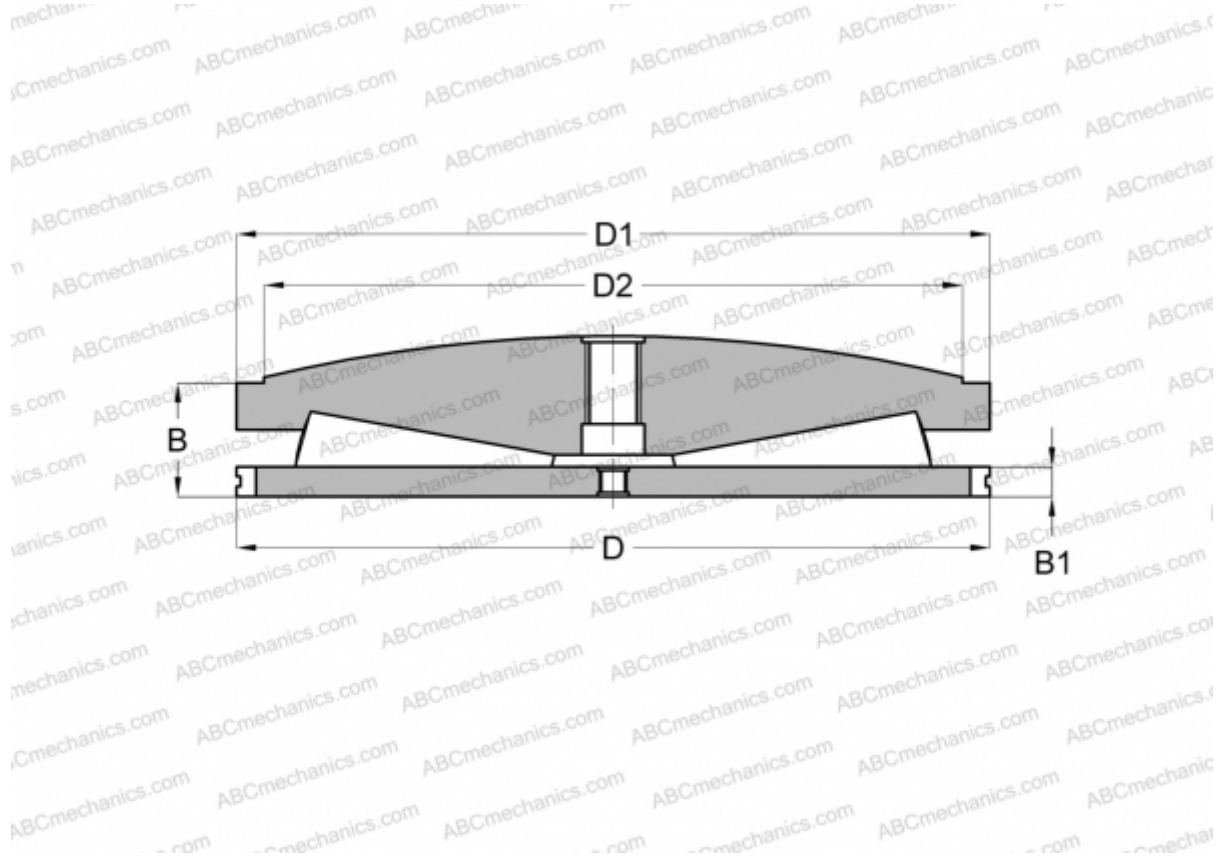

Technical specification

DIMENSIONS, MM

D	266,700
D1	264,340
D2	228,600
B	94,410
B1	19,050

WEIGHT, KG 35,500

MANUFACTURER [FAG](#)