

534470 FAG

TYPE: Roller bearings, Tapered, Thrust, For screw down mechanisms, design 2 (FAG)

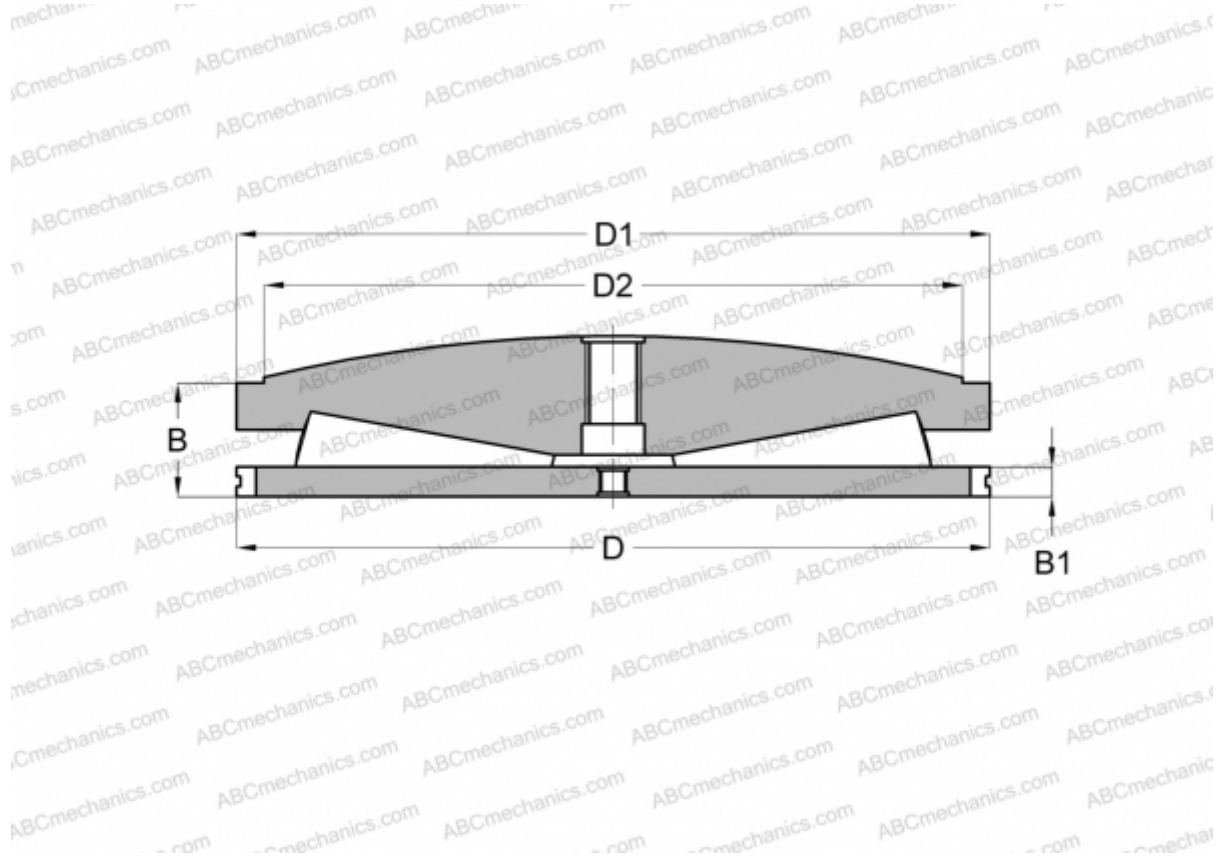

Technical specification

DIMENSIONS, MM

D	377,825
D1	375,460
D2	330,200
B	129,010
B1	25,400

WEIGHT, KG 100,000

MANUFACTURER [FAG](#)