

## 524192 FAG

TYPE: Roller bearings, Tapered, Thrust, For screw down mechanisms, design 2 (FAG)

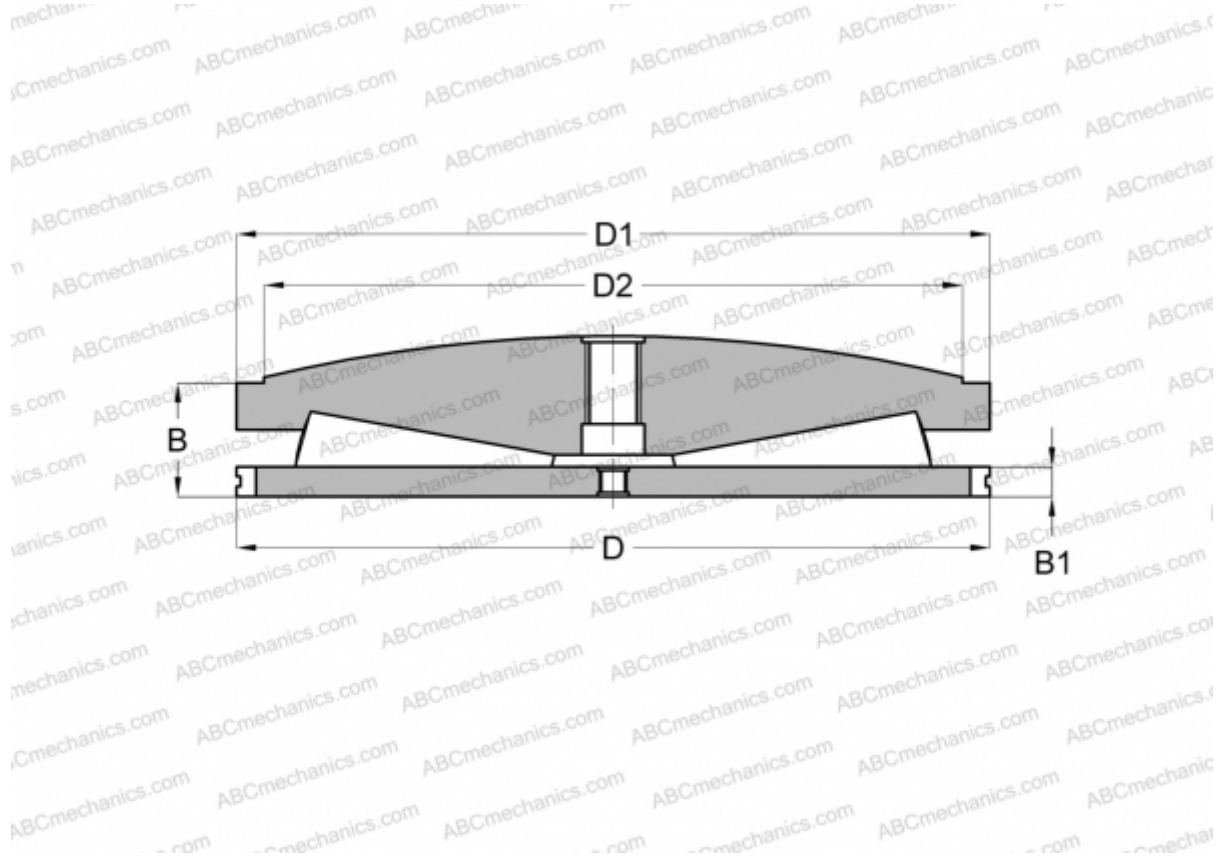

### Technical specification

#### DIMENSIONS, MM

D	409,580
D1	407,210
D2	355,600
B	140,770
B1	28,580

**WEIGHT, KG** 128,000

**MANUFACTURER** [FAG](#)