

517113 FAG

TYPE: Roller bearings, Tapered, Thrust, For screw down mechanisms, design 2 (FAG)

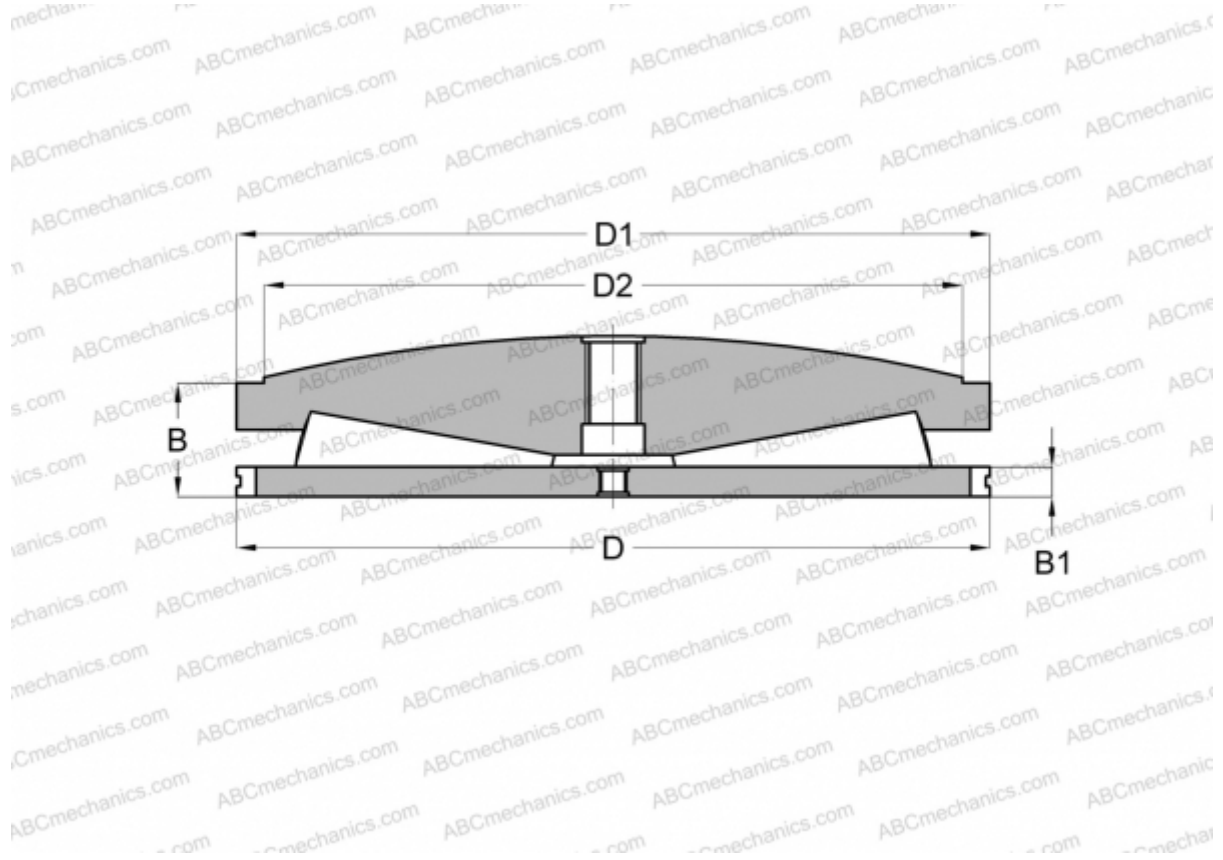

Technical specification

DIMENSIONS, MM

D	438,150
D1	435,790
D2	381,000
B	150,673
B1	31,750

WEIGHT, KG 157,000

MANUFACTURER [FAG](#)