

528348 FAG

TYPE: Roller bearings, Tapered, Thrust, For screw down mechanisms, design 2 (FAG)

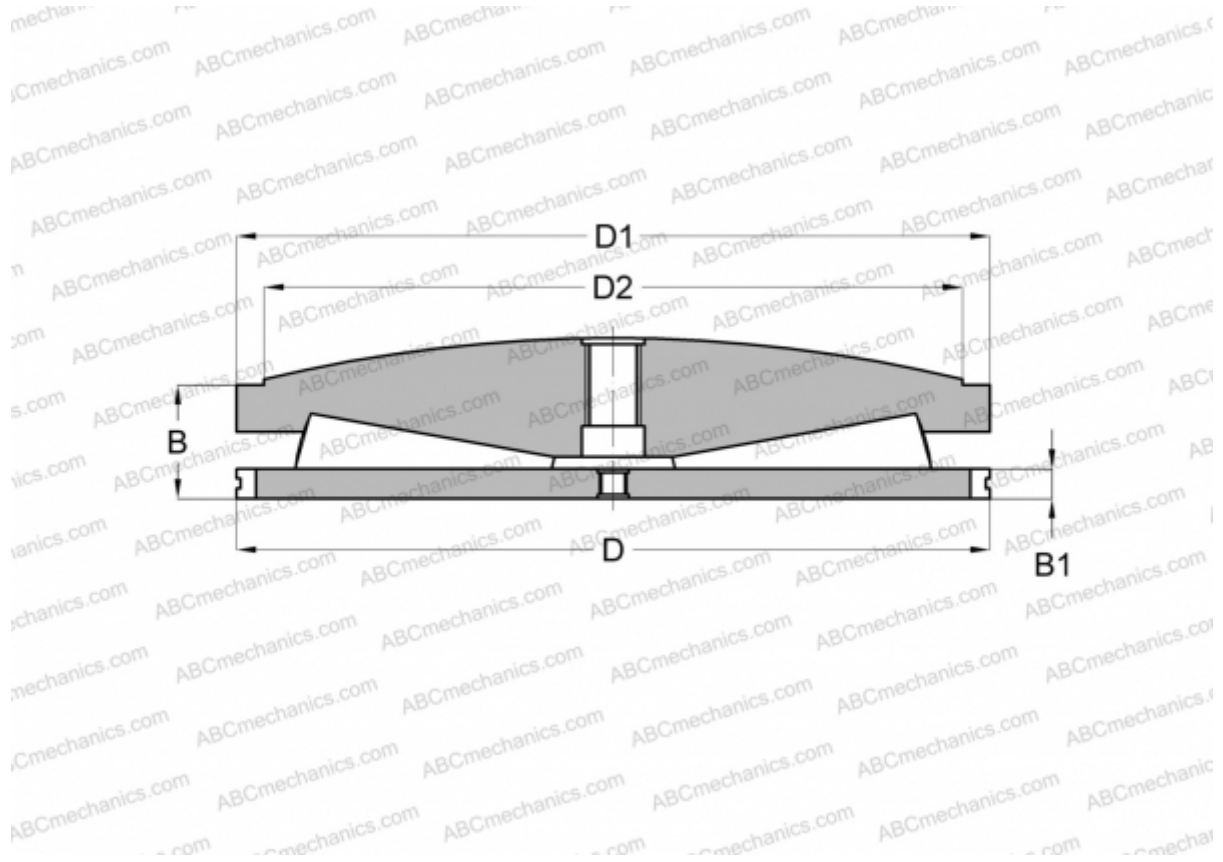

Technical specification

DIMENSIONS, MM

D	482,600
D1	482,600
D2	444,500
B	145,540
B1	38,100

WEIGHT, KG 185,000

MANUFACTURER [FAG](#)