

## 567355 FAG

TYPE: Roller bearings, Tapered, Thrust, For screw down mechanisms, design 3 (FAG)

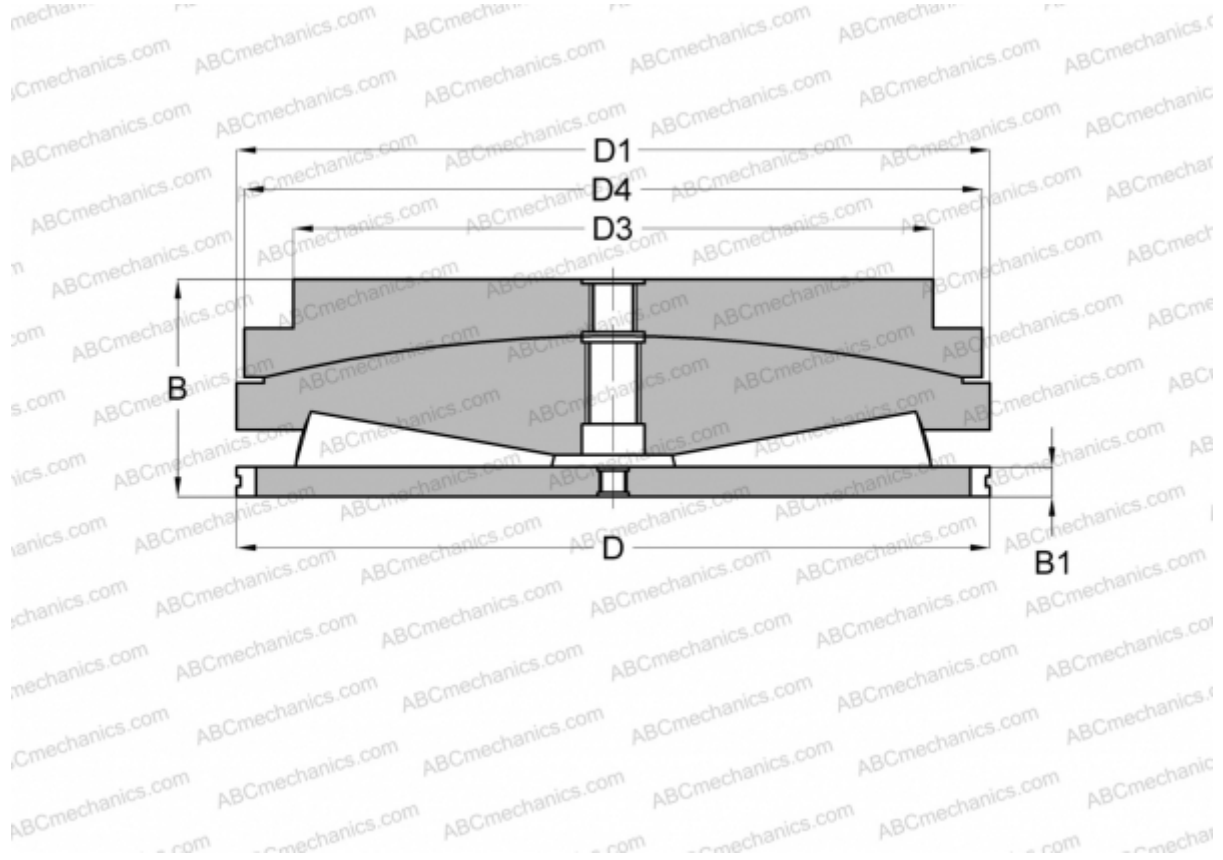

### Technical specification

#### DIMENSIONS, MM

D	320,680
D1	318,310
D3	275,000
D4	318,310
B	135,000
B1	22,230

**WEIGHT, KG** 75,000

**MANUFACTURER** [FAG](#)