

565906 FAG

TYPE: Roller bearings, Tapered, Thrust, For screw down mechanisms, design 3 (FAG)

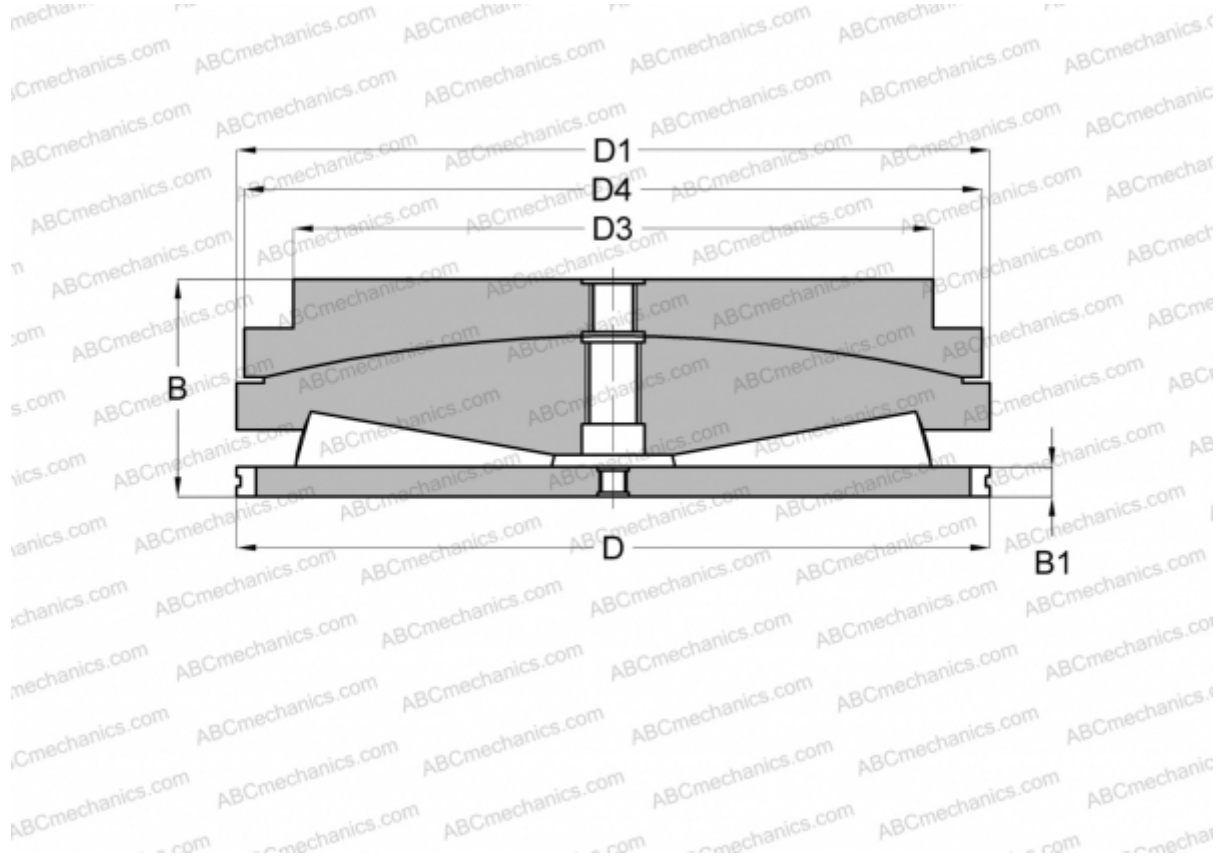

Technical specification

DIMENSIONS, MM

D	581,030
D1	578,660
D3	460,000
D4	570,000
B	243,780
B1	38,100

WEIGHT, KG 450,000

MANUFACTURER [FAG](#)