

RTWM-602 ANDREWS

Cylindrical roller thrust bearings

TYPE: Roller bearings, Thrust roller bearing, Cylindrical, Single direction, separable, cylindrical rollers, inch sizes, self-aligning

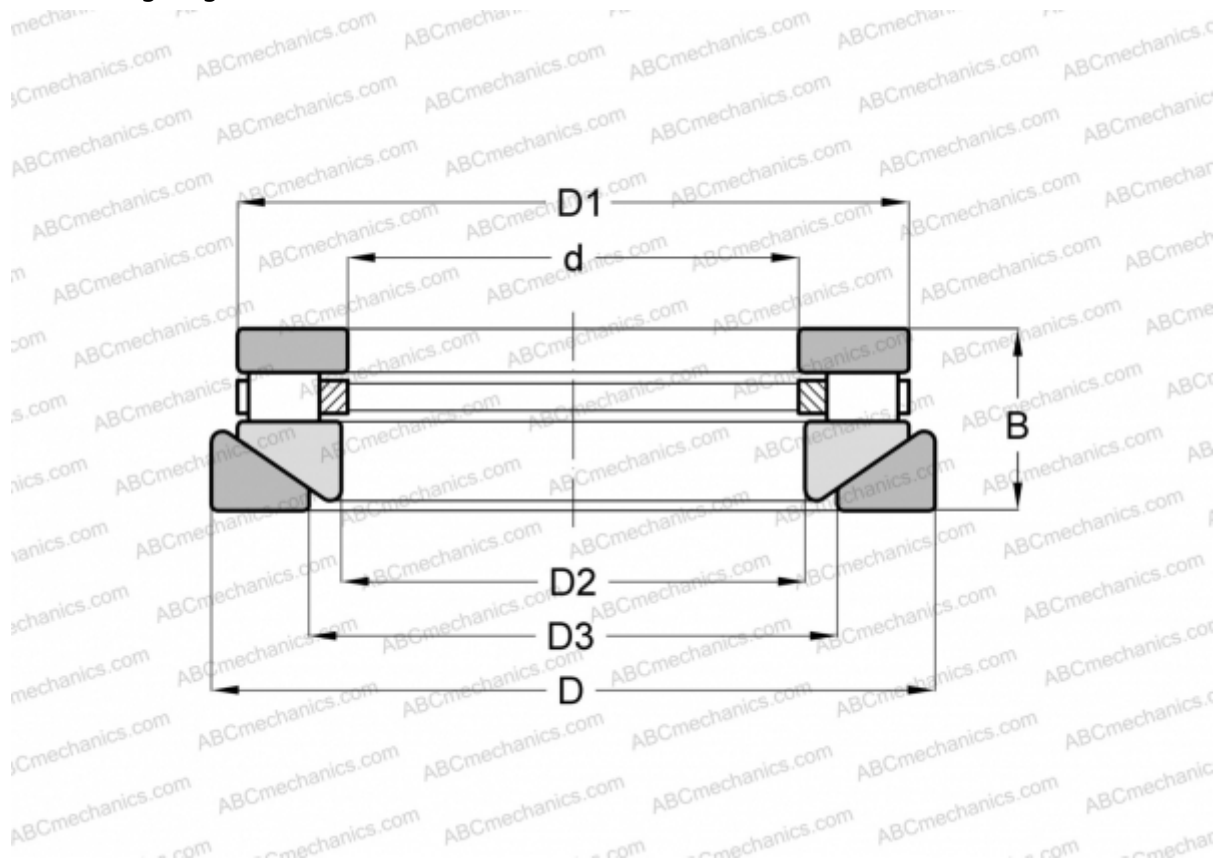

Technical specification

DIMENSIONS, MM

d	26,988
D	57,150
D1	50,800
D2	28,702
D3	33,338
B	26,988

WEIGHT, KG 0,318

MANUFACTURER [ANDREWS](#)

INTERCHANGE

ROLLWAY	AT-602
INA	RTW-602