

RTW-603 INA

Cylindrical roller thrust bearings

TYPE: Roller bearings, Thrust roller bearing, Cylindrical, Single direction, separable, cylindrical rollers, inch sizes, self-aligning

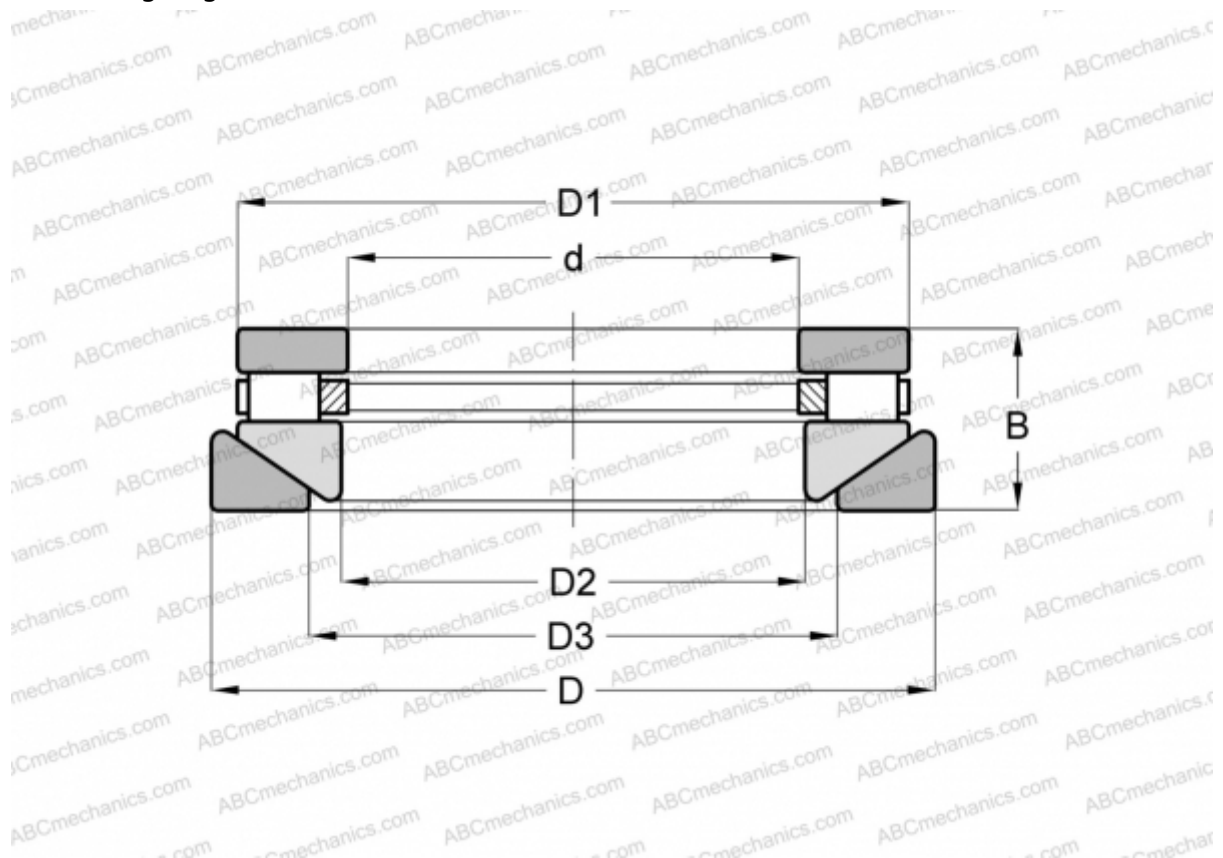

Technical specification

DIMENSIONS, MM

d	28,575
D	60,325
D1	54,768
D2	31,750
D3	36,513
B	26,988

WEIGHT, KG 0,363

MANUFACTURER [INA](#)

INTERCHANGE

ROLLWAY	AT-603
ANDREWS	RTWM-603