

## AT-604 ROLLWAY

Cylindrical roller thrust bearings

TYPE: Roller bearings, Thrust roller bearing, Cylindrical, Single direction, separable, cylindrical rollers, inch sizes, self-aligning

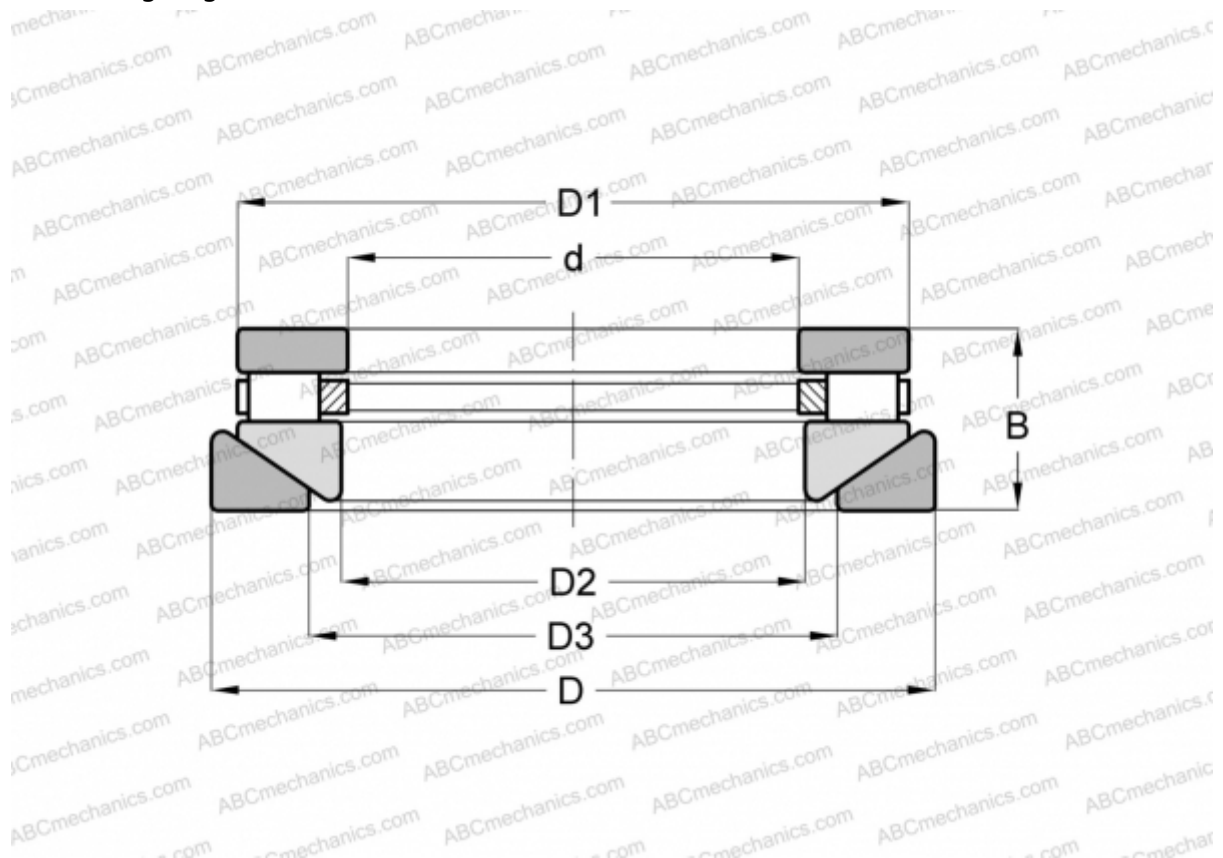

### Technical specification

#### DIMENSIONS, MM

d	30,163
D	60,325
D1	54,768
D2	31,750
D3	36,513
B	26,988

**WEIGHT, KG** 0,318

**MANUFACTURER** [ROLLWAY](#)

#### INTERCHANGE

ANDREWS	<a href="#">RTWM-604</a>
INA	<a href="#">RTW-604</a>