

AT-606 ROLLWAY

Cylindrical roller thrust bearings

TYPE: Roller bearings, Thrust roller bearing, Cylindrical, Single direction, separable, cylindrical rollers, inch sizes, self-aligning

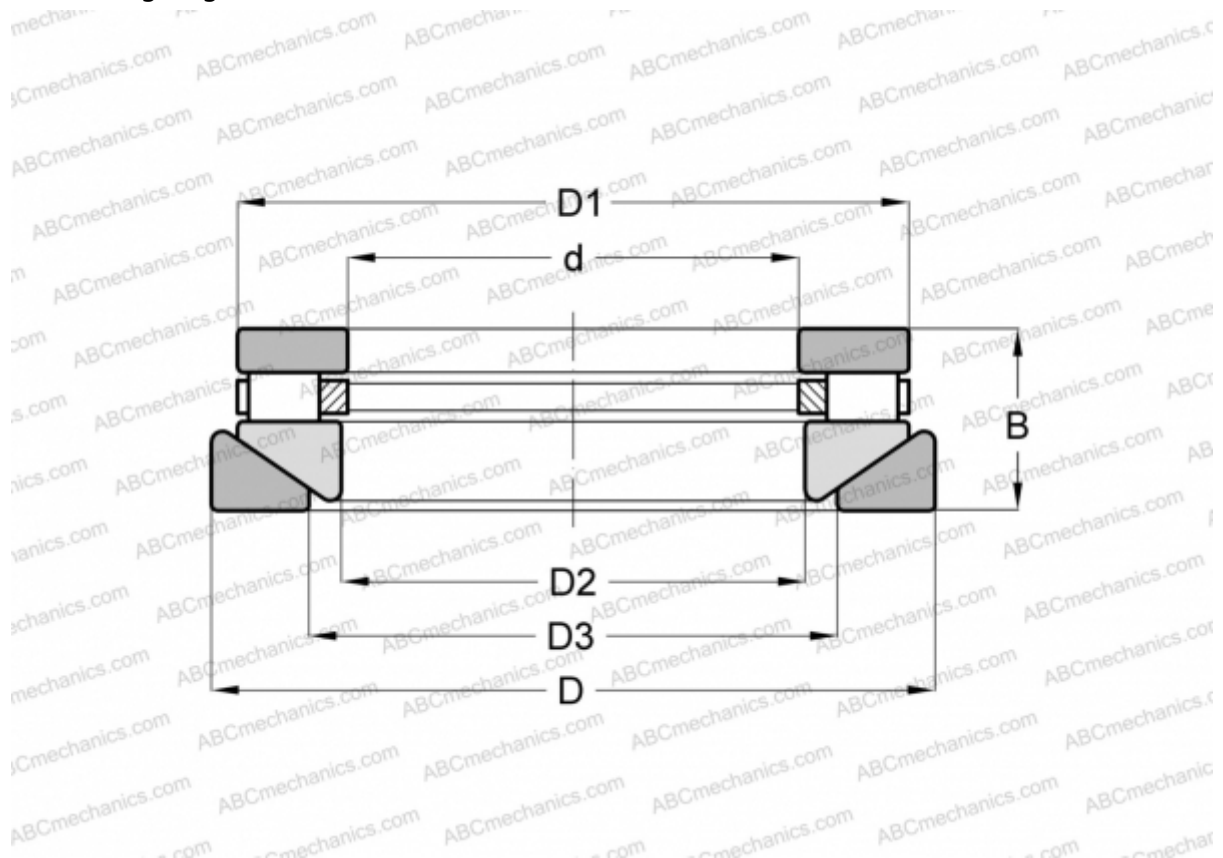

Technical specification

DIMENSIONS, MM

d	33,338
D	63,500
D1	58,738
D2	34,925
D3	41,275
B	26,988

WEIGHT, KG 0,363

MANUFACTURER [ROLLWAY](#)

INTERCHANGE

ANDREWS	RTWM-606
INA	RTW-606