

RTW-608 INA

Cylindrical roller thrust bearings

TYPE: Roller bearings, Thrust roller bearing, Cylindrical, Single direction, separable, cylindrical rollers, inch sizes, self-aligning

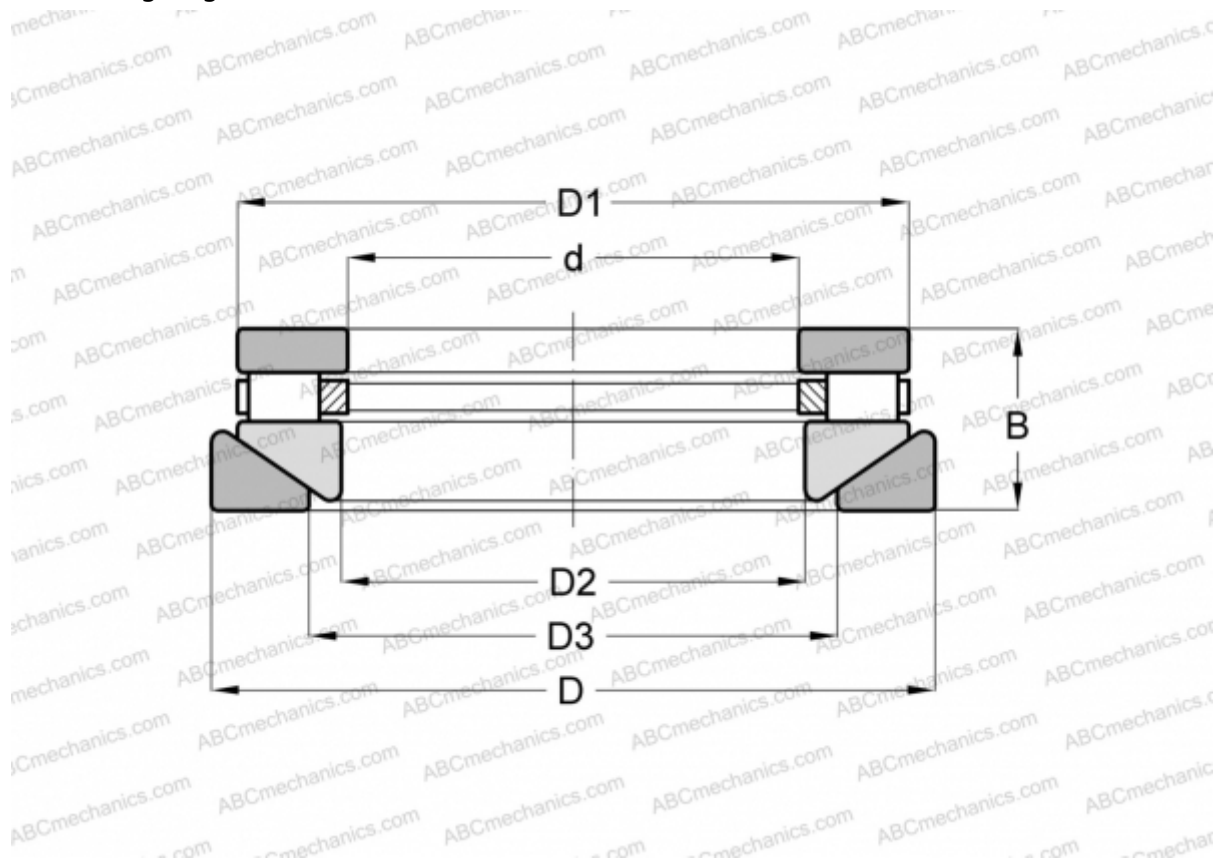

Technical specification

DIMENSIONS, MM

d	36,513
D	76,200
D1	71,041
D2	38,100
D3	46,038
B	26,988

WEIGHT, KG 0,590

MANUFACTURER [INA](#)

INTERCHANGE

ROLLWAY	AT-608
ANDREWS	RTWM-608