

RTWM-609 ANDREWS

Cylindrical roller thrust bearings

TYPE: Roller bearings, Thrust roller bearing, Cylindrical, Single direction, separable, cylindrical rollers, inch sizes, self-aligning

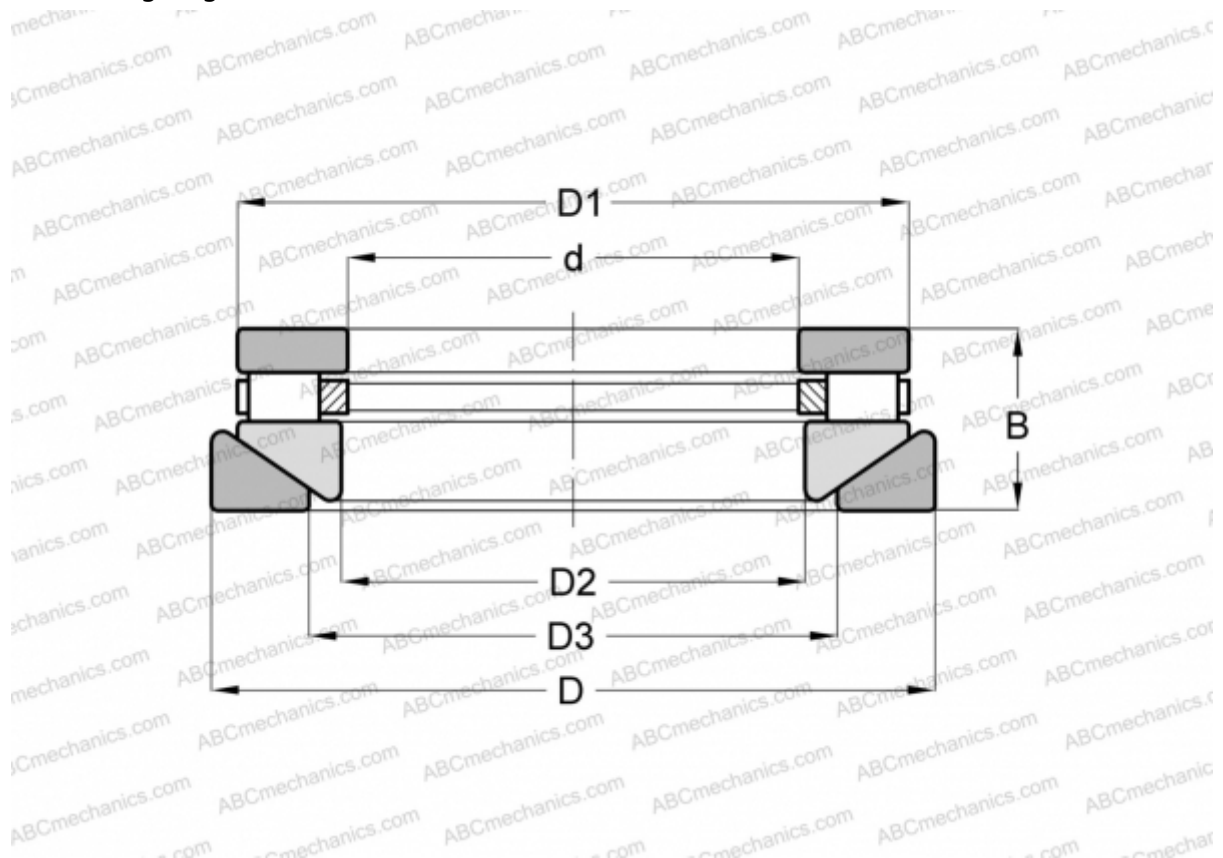

Technical specification

DIMENSIONS, MM

d	38,100
D	79,375
D1	73,818
D2	41,275
D3	47,625
B	26,988

WEIGHT, KG 0,635

MANUFACTURER [ANDREWS](#)

INTERCHANGE

ROLLWAY	AT-609
INA	RTW-609