

## RTW-611 INA

Cylindrical roller thrust bearings

TYPE: Roller bearings, Thrust roller bearing, Cylindrical, Single direction, separable, cylindrical rollers, inch sizes, self-aligning

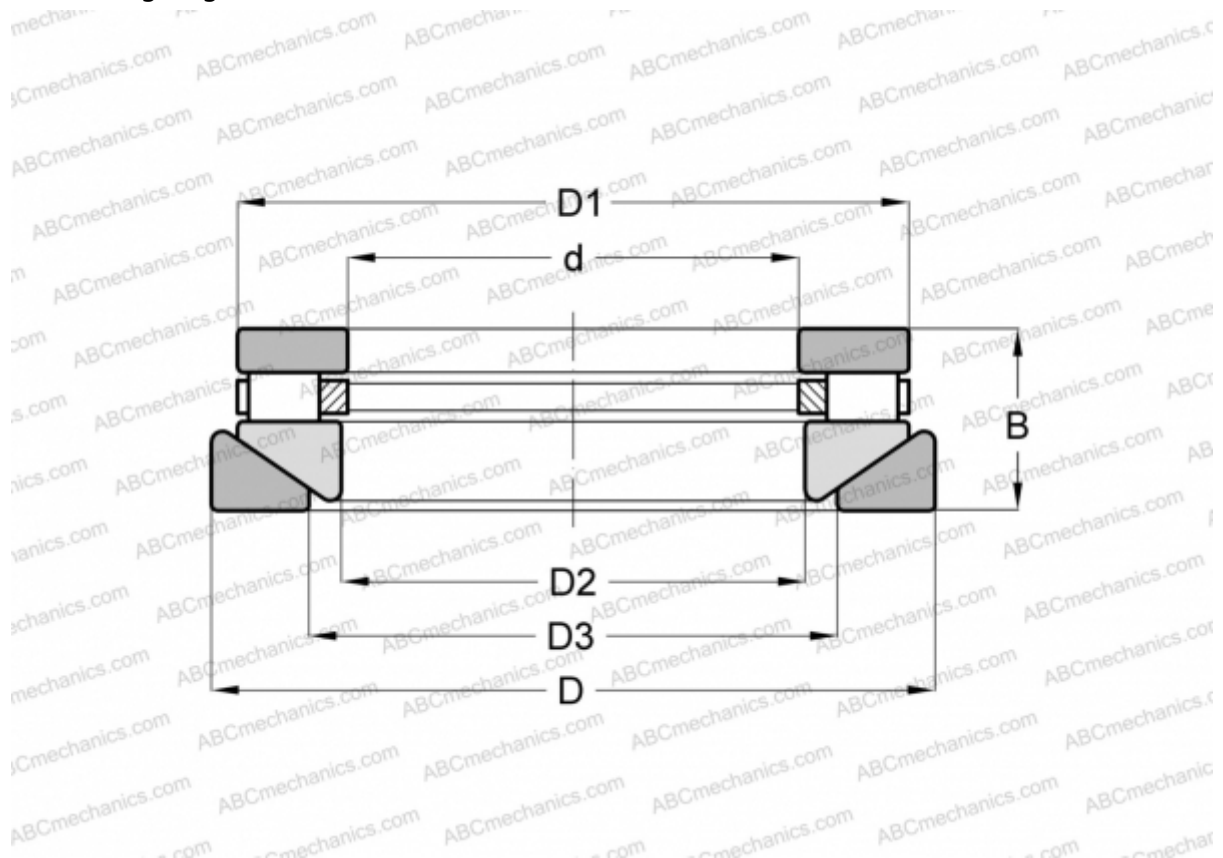

### Technical specification

#### DIMENSIONS, MM

d	41,275
D	85,725
D1	80,168
D2	44,450
D3	50,800
B	33,338

**WEIGHT, KG** 0,907

**MANUFACTURER** [INA](#)

#### INTERCHANGE

ROLLWAY	<a href="#">AT-611</a>
ANDREWS	<a href="#">RTWM-611</a>